



AdderLink IP

User Guide



[CONTENTS](#)

Contents



Introduction

AdderLink IP features - front and rear.....	4
What's in the box	5
What you may additionally need	5



Installation

Mounting	6
Connections	7
Host computer or KVM switch	7
Local keyboard, video monitor and mouse.....	8
IP network port.....	8
Modem/ISDN port.....	9
Power supply connection	9
Power control port	10

Configuration

Initial configuration	11
Part 1 – Local configuration	11
Encryption settings.....	13
Hot plugging and mouse restoration	14
Resetting the configuration	15
Part 2 – Remote configuration.....	16
Networking issues	17
Positioning AdderLink IP in the network	17
Placing AdderLink IP behind a router or firewall	17
Placing AdderLink IP alongside the firewall.....	19
Power switching configuration	20
Performing a flash upgrade.....	21

Operation

Connecting to the AdderLink IP	22
Local connection	22
Remote connections	23
Remote connection by VNC viewer.....	24
Remote connection by Web browser.....	24
Using the viewer window	25
The menu bar	25
When using the viewer window	25
Mouse pointers.....	26
Configure.....	26
Auto calibrate 	27
Re-synchronise mouse 	27
Access mode - shared/private	27
Power control	27
Controls.....	28
Connecting via dial up (modem or ISDN) link	30
Downloading VNC viewer from the AdderLink IP	30
If you need to enter a port number.....	30
Viewer encryption settings.....	31
Supported web browsers.....	31

INSTALLATION

CONFIGURATION

OPERATION

FURTHER INFORMATION

INDEX

Further information

Getting assistance.....	32
Troubleshooting	32
Appendix 1 - Local configuration menus.....	33
Unit configuration	34
Network configuration.....	35
Modem configuration	36
Reset configuration	37
Clear IP access control.....	38
Appendix 2 - VNC viewer connection options.....	39
Colour/Encoding	39
Inputs.....	40
Misc.....	40
Identities.....	41
Defaults	41
Appendix 3 - VNC viewer window options.....	42
Appendix 4 - Browser viewer options	43
Encoding and colour level.....	43
Inputs.....	43
Security	43
Misc.....	43

Appendix 5 - Remote configuration menus.....	44
User accounts	45
Unit configuration	46
Advanced unit configuration	47
Network configuration.....	48
Setting IP access control.....	49
Serial port configuration.....	50
Modem port	50
Power control.....	50
Host configuration.....	51
Logging and status	52
Appendix 6 – Addresses, masks and ports	53
IP addresses	53
Net masks	53
Net masks - the binary explanation	54
Calculating the mask for IP access control.....	55
Ports.....	56
Security issues with ports.....	56
Appendix 7 – Cable and connector specifications.....	57
RS232 serial mouse to PS/2 converter cable	57
AdderLink IP to power switch cable	57
Power switch to power switch daisy chain cable	57
Appendix 8 – Hotkey sequence codes.....	58
Other products in the Adder range.....	59
Warranty	59
Safety information	59
End user licence agreement.....	60
Radio Frequency Energy	61



INSTALLATION
CONFIGURATION
OPERATION
FURTHER INFORMATION
INDEX

Index

Introduction



Thank you for choosing the AdderLink IP from Adder Technology. This intelligent product delivers straightforward setup, secure operation and the ability to fully control one or more computers from almost anywhere.

Remote control via a network connection is nothing new and software-only solutions to facilitate this are commonplace. However, they all present two major drawbacks: a) Special software must be used on all of the computers involved, especially the host, and b) if that host ceases to operate, the remote user is powerless to intervene.

AdderLink IP is different and requires only the remote system(s) to run a small utility. The host system can run its usual operating system completely unchanged and needs only to be connected (via its keyboard, video and mouse ports) to the compact AdderLink IP box.

It is this external connection to the AdderLink IP that keeps the remote user in control. Even in the midst of a system crash, the remote user can still view the host's condition as if sitting next to it. Additionally, when the power switch option is employed, a host system can be remotely rebooted, no matter how badly it has locked-up.

AdderLink IP really starts to excel when it is hooked to a suitable KVM switch. Then its robust, secure and adaptable operation is available across a multitude of systems.

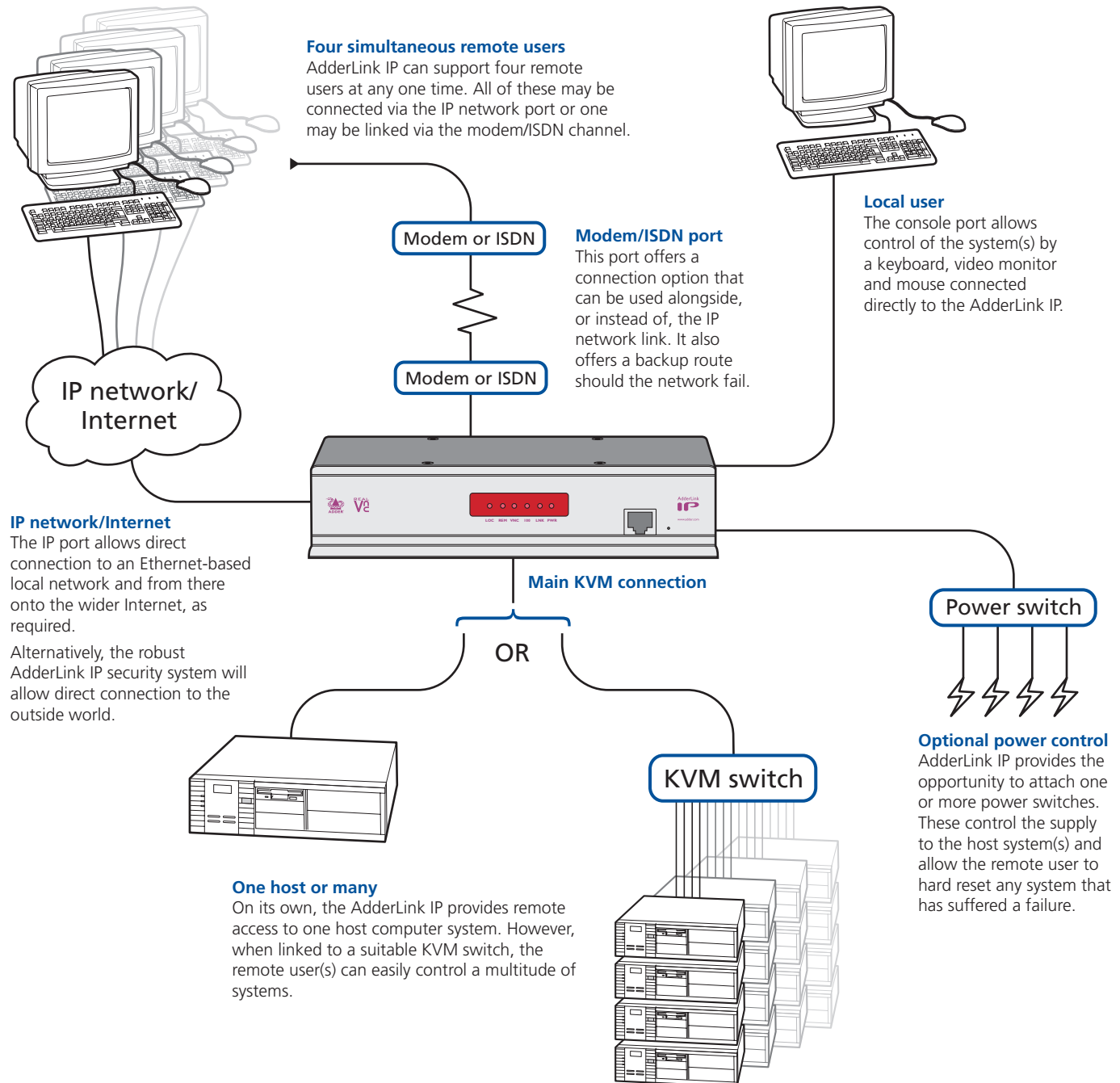

- INSTALLATION
- CONFIGURATION
- OPERATION
- FURTHER INFORMATION
- INDEX

AdderLink IP features - front and rear

Considering its capabilities, the AdderLink IP is supplied within a remarkably compact casing. Measuring just 198mm x 120mm x 43mm, it occupies just half of a single (1U) rack space and provides most of its connectors at the rear face. The smart front face features the IP network port and the operation indicators.



Created through partnership

The AdderLink IP is the result of a creative partnership between two companies that are leaders in their respective markets:



Adder Technology Limited are renowned worldwide for their professional KVM switching hardware.



RealVNC are creators of remote control software for a wide variety of computer systems. Speed, simplicity and security are their particular strengths.

IP network port

This intelligent Ethernet port can automatically sense whether it is attached to a 10Mb or 100Mb network.

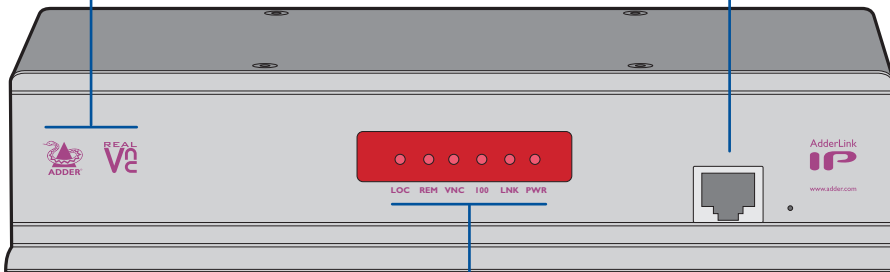

Indicators

These six indicators clearly show the key aspects of operation:

- **LOC** Keyboard or mouse data is being received from the local console.
- **REM** Keyboard or mouse data is being received from a remote viewer.
- **VNC** Indicates that a remote viewer is connected and active.
- **100** Indicates the Ethernet network speed (10/100Mbps).
- **LNK** Network link and activity indication.
- **PWR** Power indicator.

Power control port

Optionally use this port to control one or more power switches. These allow the remote user to take full control of the host system(s).

Modem port

Optionally use this port to attach either a standard modem or an ISDN adapter. This feature provides an alternative, direct-dial, remote link into the AdderLink IP.

Power input

Connect the supplied power adapter here.

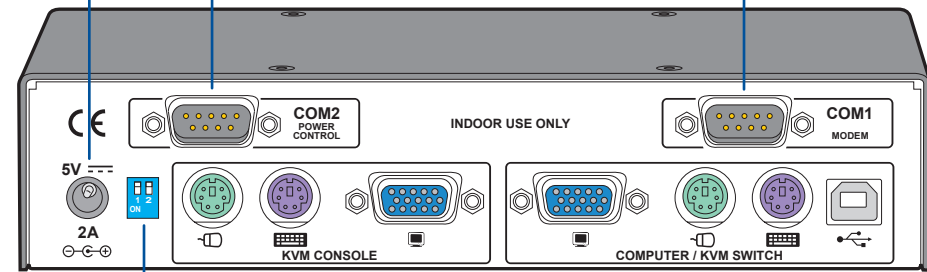

Configuration switches

Used for flash upgrades and total reset functions. They are not required under normal circumstances.

KVM console

Connect a keyboard, video monitor and a mouse to these three connectors. These allow you to perform the initial configuration of the AdderLink IP. Additionally, you can use these to locally control the connected computer(s).

Computer/KVM Switch

Link these connectors to the keyboard, video and mouse ports of the device to be remotely controlled, either a single computer or a KVM switch. The USB port on the right is for future expansion and is not currently used.

INSTALLATION

CONFIGURATION

OPERATION

FURTHER INFORMATION

INDEX

What's in the box

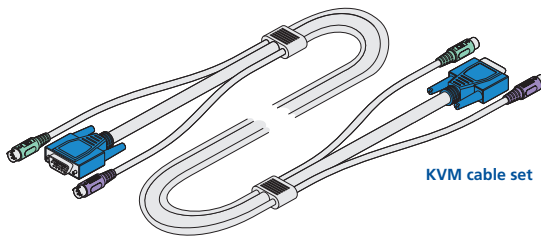
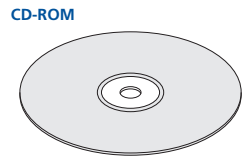
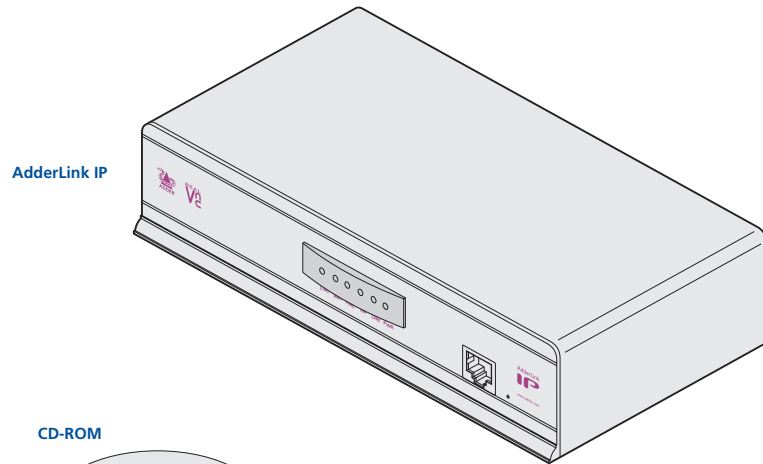

What you may additionally need

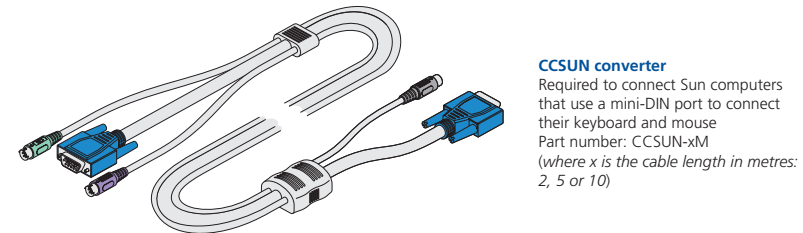
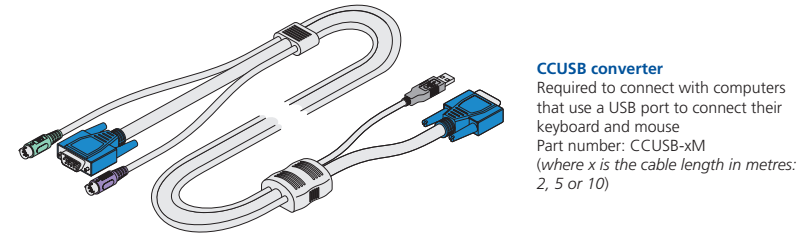
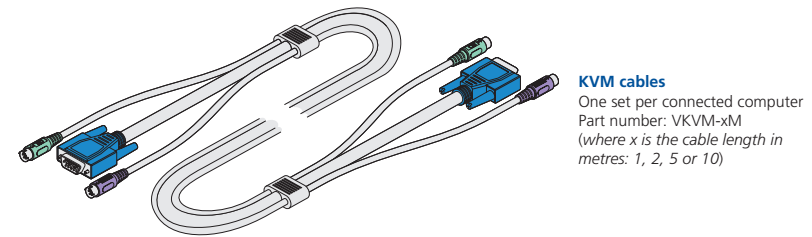
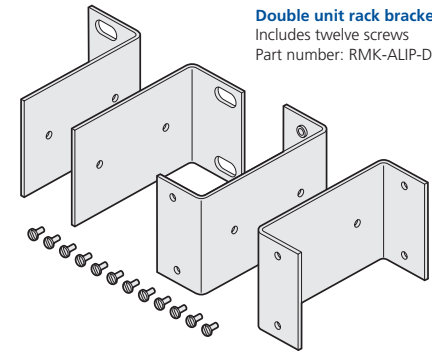
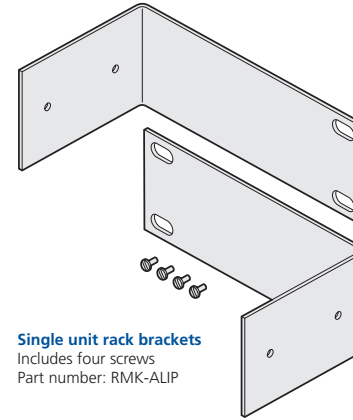

Slave power switches for connection to AdderLink IP or master power switch (part number: EPS-S8)

Master power switch for connection to AdderLink IP or standalone Ethernet operation (part number: EPS-M8)

PS/2 to AT-style keyboard converter (part number: VSA3)

PS/2 to 9-pin serial mouse converter (part number: VSA1)



INSTALLATION

CONFIGURATION

OPERATION

FURTHER INFORMATION

INDEX

Installation

Mounting

AdderLink IP offers three main mounting methods:

- Supplied four self-adhesive rubber feet
- Optional single unit rack brackets
- Optional double unit rack brackets

Connections

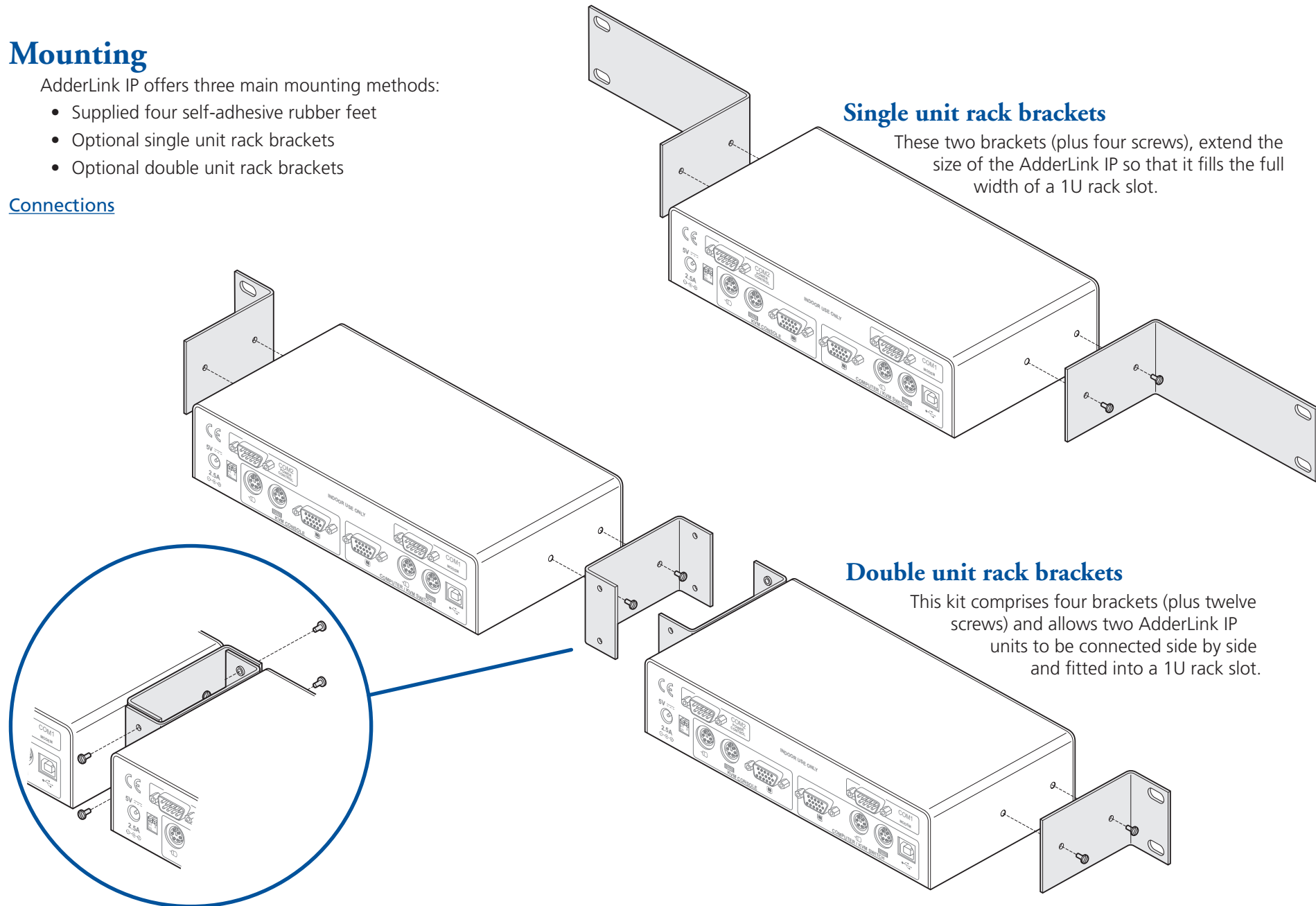

Single unit rack brackets

These two brackets (plus four screws), extend the size of the AdderLink IP so that it fills the full width of a 1U rack slot.

Double unit rack brackets

This kit comprises four brackets (plus twelve screws) and allows two AdderLink IP units to be connected side by side and fitted into a 1U rack slot.

Connections

Installation of the AdderLink IP involves a number of basic connections to some or all of the following items:

- Host computer or KVM switch ⇔
- [Local keyboard, video and mouse](#)
- [IP network port](#)
- [Modem/ISDN port](#)
- [Power input](#)
- [Power control port](#)

Host computer or KVM switch





The AdderLink IP can either connect directly to a single host computer or to range of hosts via one or more KVM switches.

To connect a host computer or KVM switch

- 1 Ensure that power is disconnected from the AdderLink IP and the computer or KVM switch to be connected.

(Note: If it is not possible to switch off devices prior to connection, then a 'Hot plug' procedure is available – see the [Hot plugging and mouse restoration](#) section for more details).

- 2 Connect the plugs at one end of a KVM cable set to the keyboard, video and mouse sockets of the computer or KVM switch (for mouse plug conversion information – see [Appendix 7](#)).

Monitor (video)		Blue
Keyboard		Purple
Mouse	 or 	Mid green

- 3 Connect the plugs at the other end of the KVM cable set to the corresponding sockets, collectively labelled as 'COMPUTER/KVM SWITCH', at the rear of the AdderLink IP.

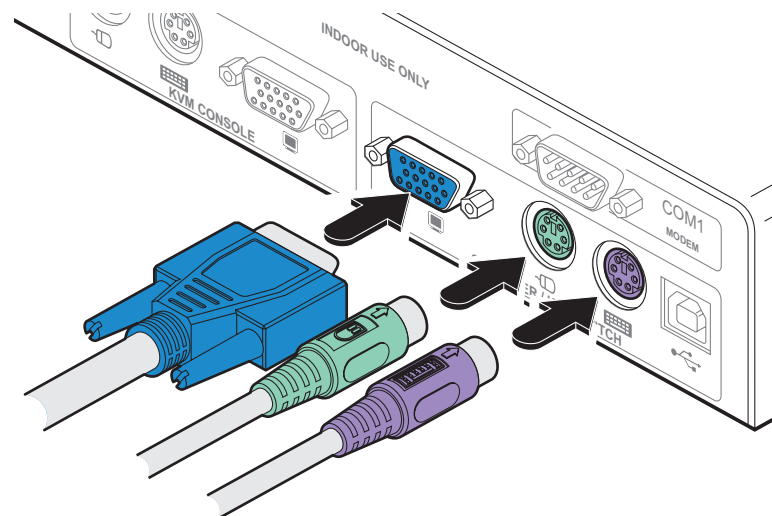

Local keyboard, video monitor and mouse

A locally connected keyboard, video monitor and mouse are required during the initial configuration. These are also useful during normal use to allow quick local control of any connected host computers.

To connect a local keyboard, video monitor and mouse

- 1 Position a suitable keyboard, video monitor and mouse in the vicinity of the AdderLink IP such that their cables will easily reach.
- 2 Connect the keyboard, video monitor and mouse plugs to the sockets, collectively labelled as 'KVM CONSOLE', at the rear of the AdderLink IP.

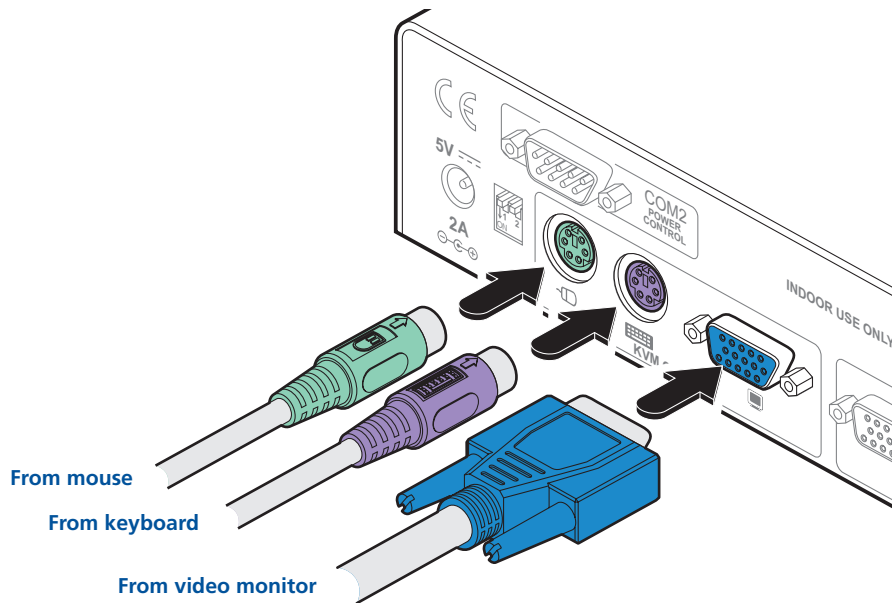

IP network port

The AdderLink IP provides an autosensing Ethernet IP port that can operate at 10 or 100Mbps, according to the network speed. The AdderLink IP is designed to reside quite easily at any part of your network:

- It can be placed within the local network, behind any firewall/router connections to the Internet, or
- It can be placed externally to the local network, on a separate sub-network or with an open Internet connection.

Wherever in the network the AdderLink IP is situated, you will need to determine certain configuration issues such as address allocation and/or firewall adjustment to allow correct operation. Please refer to [Networking issues](#) within the Configuration chapter for more details.

IMPORTANT: When the AdderLink IP is accessible from the public Internet or dial up connection, you must ensure that sufficient [security measures](#) are employed.

To connect the IP network port

- 1 Depending upon where in the network the AdderLink IP is being connected, run a category 5e or 6 cable from the appropriate hub or router to the AdderLink IP.
- 2 Connect the plug of the category 5e or 6 cable into the IP port on the front panel of the AdderLink IP.

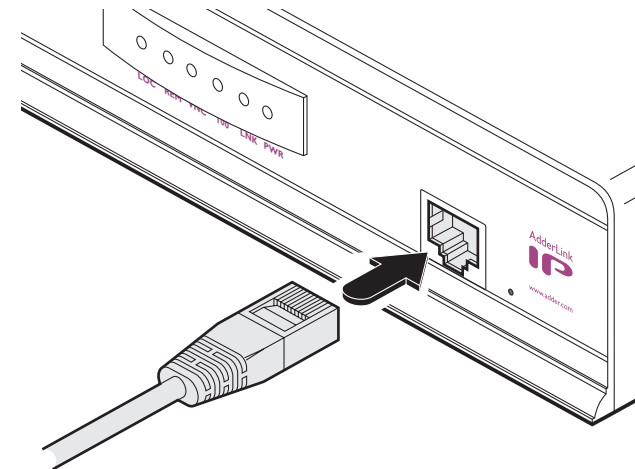

- 3 Configure the network settings as appropriate to the position of the AdderLink IP within the network - see [Networking issues](#) for details.



Modem/ISDN port

The AdderLink IP provides a serial port specifically for you to connect either a modem or ISDN terminal adapter. This can be used as a primary, secondary or backup access port for remote systems, as best suits your overall configuration.

IMPORTANT: When the AdderLink IP is accessible from the public Internet or dial up connection, you must ensure that sufficient [security measures](#) are employed.

To connect a modem or ISDN port

- 1 If possible, disconnect power from the AdderLink IP and the modem or ISDN adapter.
- 2 Connect a suitable serial modem (non-crossover) cable to the serial port on the modem/ISDN adapter.
- 3 Connect the other end of the serial cable to the port labelled COM1 at the rear of the AdderLink IP.

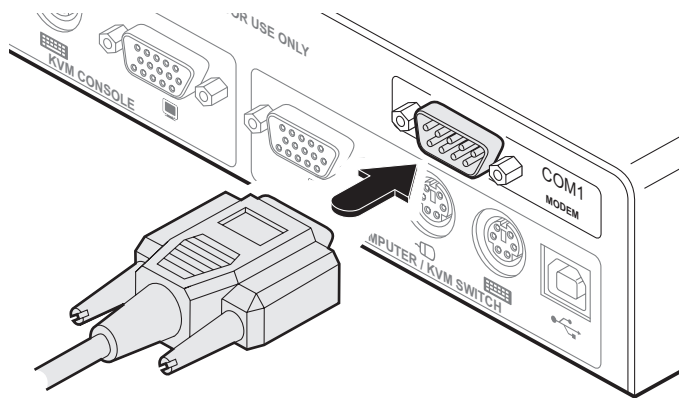

Note: The default serial port speed is 115200K and a standard Hayes-compatible auto-answer string is sent during startup. The default startup string is 'ATZHS0=1'. Both the serial port speed and startup string settings can easily be altered during the local or remote configuration - see [Initial configuration](#) for more details. The other serial settings are fixed at: No parity, 8 bit word and 1 stop bit.

Power supply connection

The AdderLink IP is supplied with a single power supply and an appropriate country-specific IEC power lead. There is no on/off switch so operation begins as soon as the power supply is connected.

To connect the power supply

- 1 Connect the low voltage output connector from the power supply unit to the power socket on the rear panel of the AdderLink IP.

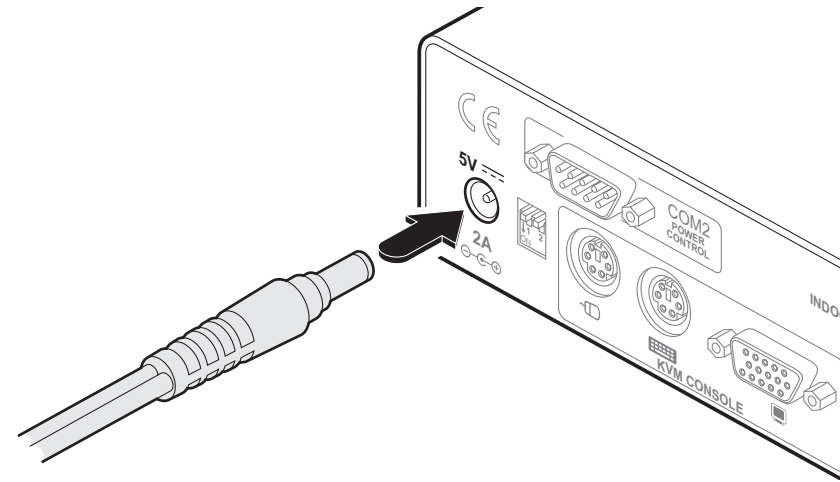

- 2 Connect the IEC connector of the supplied country-specific power lead to the socket of the power supply.
- 3 Connect the power lead to a nearby main supply socket.

Power control port

The AdderLink IP provides a serial port for connection to one or more optional power control units. This allows you to control the mains power being supplied to the connected host(s) so that an authorised remote user can, if necessary, perform a complete cold reboot on a failed host system.

The control connector of the first power switch is connected, via serial cable, to the rear panel of the AdderLink IP. Any additional power switches are then connected via a 'daisy-chain' arrangement to the first power switch. Each power switch box is then given a unique address and access to each power port (8 ports on each power switch box) is gained using a combination of the switch box address and the port number.

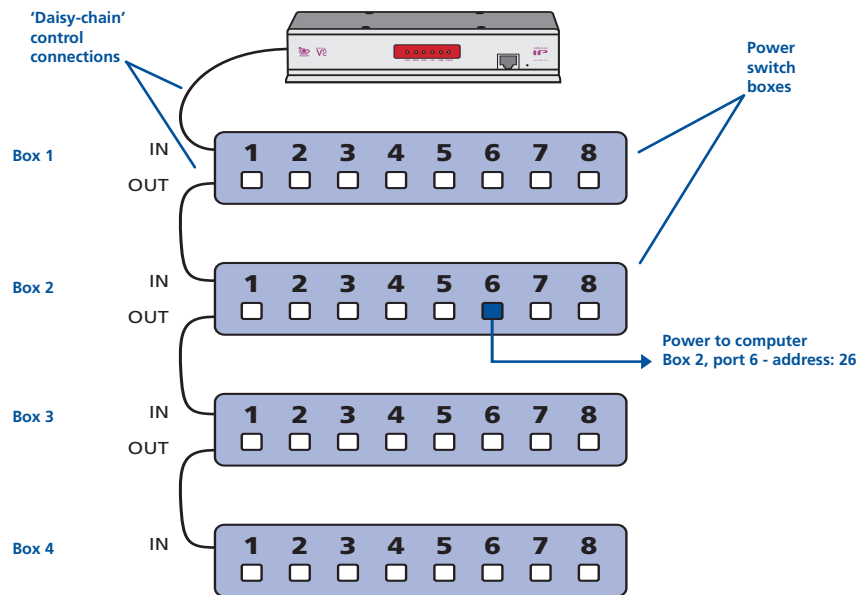

The power ports are connected to the power inputs of each computer and the power switch box(es) are then connected to a mains power supply.

IMPORTANT: Power switching devices have a maximum current rating. It is essential to ensure that the total current drawn by the equipment connected to the power switching device does not exceed the current rating of the power switching device. You must also ensure that the current drawn from any mains socket does not exceed the current rating of the mains socket.

Setting up, configuring and using power switching requires three main steps:

- Connect and address the switch boxes ⇔
- [Configure the power strings](#)
- [Operate remote power switching](#)

To connect and address the switch boxes

Note: The AdderLink IP can be powered on during this procedure, however, the switch boxes should be switched off.

- 1 Mount up to four switch boxes in positions where they are close to the computers that they will control and not too distant from the AdderLink IP (preferably within 2.5 metres).
- 2 Use a serial cable with an RJ9 and a 9-pin D-type connector (see [Appendix Z](#) for specification). Connect the RJ9 plug to the socket marked 'IN' on the first switch box. Connect the other end to the socket marked 'COM2' on the AdderLink IP.

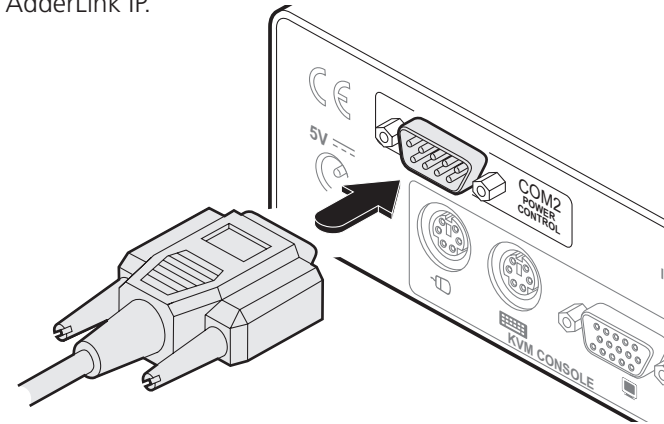

- 3 For each of the remaining switch boxes (if used), use a serial cable with RJ9 connectors at both ends (see [Appendix Z](#) for specification). Connect one end to the socket marked 'OUT' of the previous box and the other end to the socket marked 'IN' of the next box.

- 4 Set the addressing switches on each switch box using the two micro switches marked 'Slct' on the front panel. The box connected directly to the AdderLink IP is Box 1 and so on, down the daisy-chain line to Box 4 at the end.

Box	Switch 1	Switch 2
1	Off	Off
2	On	Off
3	Off	On
4	On	On

Off = switch upwards
On = switch downwards
Switch 1 is on the left side

- 5 Connect IEC to IEC power leads between each port and the power input socket of each computer that requires power switching. Carefully note to which power ports, on which boxes, each computer is connected. If server systems have multiple power inputs, then each input must be connected via separate ports, which can be on the same, or different boxes.

- 6 Connect each box to a suitable mains power input.

Now proceed to the configuration stage covered in the [Power switching configuration](#) section within the Configuration chapter.

Configuration



Initial configuration

The initial configuration occurs as two distinct parts:

Part 1 – Local configuration

This part of the configuration takes place using the locally connected keyboard and video monitor. It allows you to set up key basic details, network essentials, modem/ISDN parameters and security key creation.

Part 2 – Remote configuration

This part of the configuration takes place using a remote connection (network or dial-up modem/ISDN). It allows fine tuning of the part 1 configuration items plus the creation of multiple user accounts and host details. Go to [Part 2 - Remote configuration](#).

Part 1 – Local configuration

When you switch on the AdderLink IP unit for the first time it will take you (using the locally connected keyboard and video monitor) through a set up sequence consisting of four main screens:

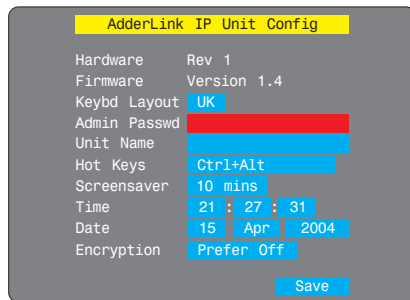

Unit config screen

Allows you to determine a mixture of basic and fundamental setup details such as the keyboard layout, admin password, time and date.

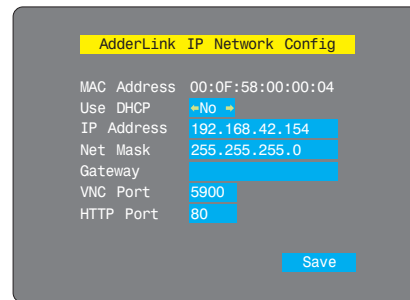

Network config screen

Requires you to configure the various key aspects of the IP network port addressing.

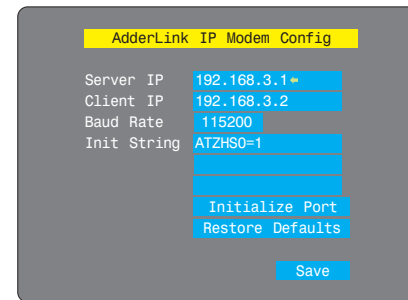

Modem config screen

Allows you to optionally alter the current settings for the serial port that is used to connect a modem or ISDN terminal adapter. The IP addresses are used to emulate a two-port network connection and are suitable for most situations.

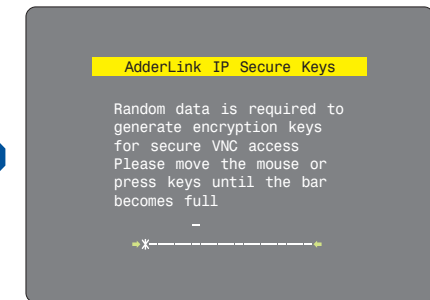

Secure keys screen

This screen uses your mouse movements or keyboard inputs to create random data. This unpredictable information is then combined with several other factors to develop the basis of the encryption keys that are used to establish secure remote links.

Controlling the local configuration menus

The local menus use only the keyboard. Use the keyboard arrow keys to move the green highlight indicator to the required position. Then, either type the required information or use the left and right arrows to change multiple choice items, as appropriate.

Problems?

[The AdderLink IP asks for an unknown admin password](#)

[The AdderLink IP does not display the configuration sequence](#)

continued

INSTALLATION

CONFIGURATION

OPERATION

FURTHER INFORMATION

INDEX

To perform the initial local configuration

1 Edit the Unit config screen. The key elements here are:

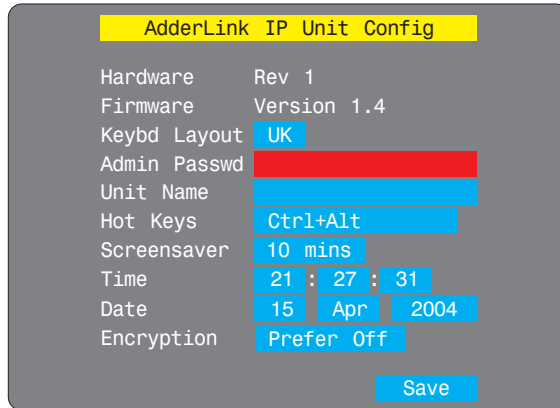

Admin password

Enter a password of at least six characters that has a mix of letters and numerals. The background colour provides an indication of password suitability and is initially red to indicate that the password is not sufficient. When a password with reasonable strength has been entered it changes to blue.

Time and Date

Set these correctly as all entries in the activity log are time stamped using them.

Encryption

Arrange this setting according to your security requirements. See [Encryption settings](#) for a description of the issues and the settings.

When all items are correct, select the Save option to display the next screen.

2 Edit the Network config screen. The key elements here are:

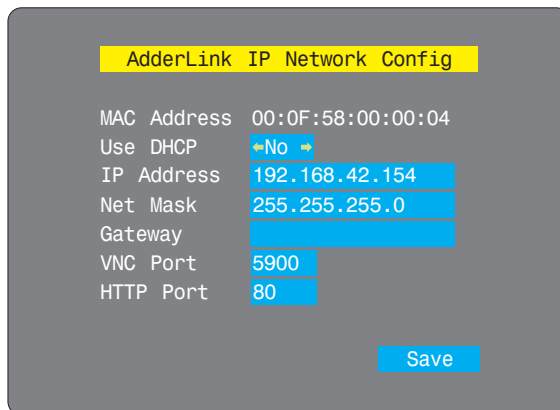

Use DHCP/IP address/Net Mask/Gateway

You need to either set the DHCP option to 'Yes' or manually enter a valid IP address, Net mask and Gateway. See [Networking issues](#) for more details.

VNC and HTTP ports

These should remain set to 5900 and 80, respectively, unless they clash with an existing setup within the network. See [Networking issues](#) for more details.

When all items are correct, select the Save option to display the next screen.

3 If necessary, edit the Modem config screen.

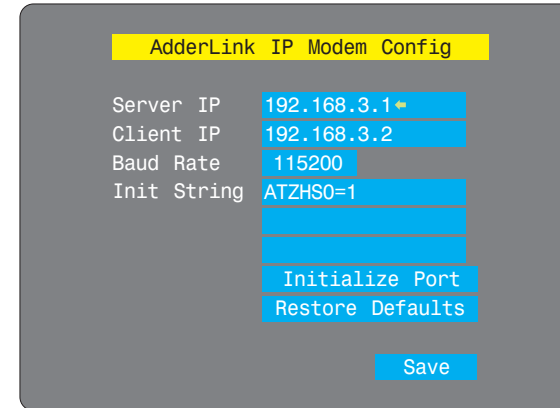

The default items here are perfectly adequate for the majority of modem and ISDN terminal adapter installations. The Server IP and Client IP addresses are used to form an isolated two-device PPP network connection via the dial up link. Their settings are not related to any other 'real' network settings within the AdderLink IP.

When all items are correct, select the Save option to display the next screen.

4 Move the mouse and enter changing key sequences within this screen.

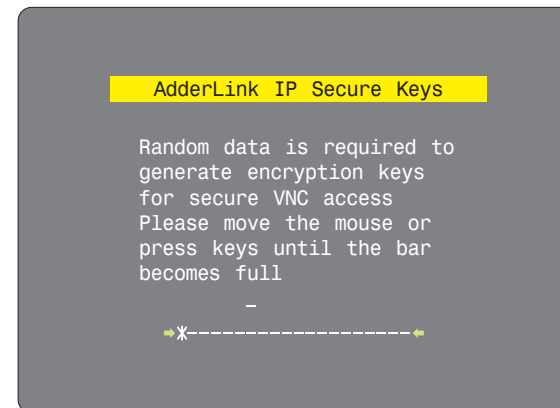

With every mouse move and keypress, the single dash will move across the screen (unless the same key is pressed repeatedly). Periodically, a new star character will be added to the bar as the random data is accepted as part of the new encryption key. When the bar is full, the final encryption keys for your AdderLink IP will be created – this process takes roughly 30 to 40 seconds.

continued

- 5 Once the secure keys have been calculated the AdderLink IP will restart and present a standard logon screen.

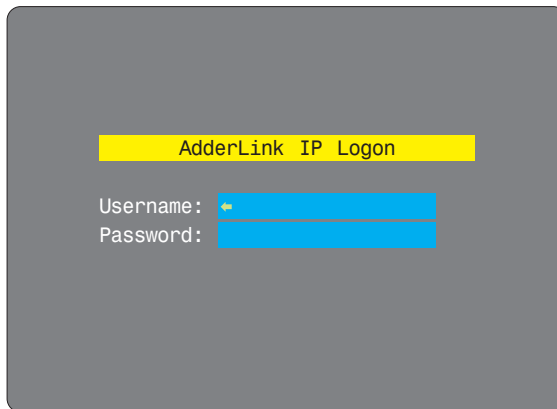

At this stage the username will be 'admin' and the password will be whatever you entered in the first setup screen.

Once the username and password have been accepted, the screen should now show the host computer screen (or, if none is connected, a blank image).

- 6 To view the options menu: Press **Ctrl** **Alt** **C**. [More about hotkeys](#). (if the standard hotkeys were altered, use the new hotkeys plus C)

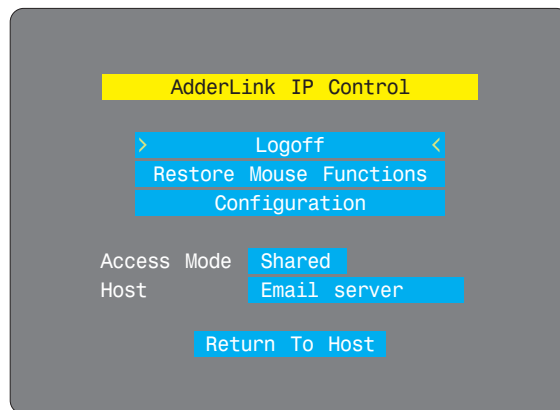

Access mode

Allows you to choose between Shared mode (where all other logged on users can see your operations) and Private mode (where the screens of all other users are blanked).

Logoff

Select to close your current session and display the screensaver.

Restore mouse functions

Select to revive a mouse that has ceased to function correctly. See [Hot plugging and mouse restoration](#) for details.

Configuration

Select to gain access to the Unit, Network and Modem configuration screens. Within here you can also reset the AdderLink IP to its initial state.

Host

Indicates the currently selected host computer and allows you to select others. This item will be blank unless host details have been set within the [remote configuration](#).

Return to host

Quits the menu and returns to the host screen.

Encryption settings

The AdderLink IP offers a great deal of flexibility in its configuration and this extends equally to its encryption settings. Due to the variety and of situations in which it might be used and the range of viewer applications that need to view it, a number of settings are available that might not make perfect sense at first glance. However, these settings should allow you to configure the AdderLink IP and the viewers to operate as required.

Factors to consider when setting these options might be:

- Do all of the connections and operations require encryption?
- Will some users be using older VNC viewer versions?

AdderLink IP encryption settings

The AdderLink IP configuration page offers three encryption settings:

- **Always on** - This setting will force all viewers to use encryption. *Note: This setting will preclude any VNC viewer versions that do not support encryption.*
- **Prefer off** - This setting does not enforce encryption unless a viewer specifically requests it. If a viewer has its 'Let server choose' setting, then an un-encrypted link will be set up.
- **Prefer on** - This setting generally enforces encryption unless an earlier viewer version is unable to support it, in which case the link will be un-encrypted. If a viewer has its 'Let server choose' setting, then the link will be encrypted.

Viewer encryption settings

The web browser viewers and VNC viewers (of level 4.0b5S or higher) offer four encryption settings:

- **Always on** - This setting will ensure that the link is encrypted, regardless of the AdderLink IP encryption setting.
- **Let server choose** - This setting will follow the configuration of the AdderLink IP. If the AdderLink IP has 'Always on' or 'Prefer on' set, then the link will be encrypted. If the 'Prefer off' setting is selected at the AdderLink IP, then the link will not be encrypted.
- **Prefer off** - This setting will configure an un-encrypted link if the AdderLink IP will allow it, otherwise it will be encrypted.
- **Prefer on** - If the AdderLink IP allows it, this setting will configure an encrypted link, otherwise it will be un-encrypted.



Hot plugging and mouse restoration

It is strongly recommended that you switch off a host computer before attempting to connect it to the AdderLink IP. However, if this is not possible then you need to 'hot plug' the computer while it is still running. There is not normally a danger of damage to the computer, however, when mouse communications are interrupted, often they fail to re-initialise when reconnected. The AdderLink IP provides a feature to reinstate mouse communications once the necessary connections have been made.

There are two main types of data formats used by current PC mice, these are the older 'PS/2' format and the more recent 'IntelliMouse®' format introduced by Microsoft. These use slightly different data arrangements and it is important to know which type was being used before you hot-plugged the computer to the AdderLink IP. The previous setting depends both on the type of mouse and the type of driver, as various combinations of PS/2 and IntelliMouse are possible. Using the incorrect restore function may produce unpredictable results and require the computer to be re-booted.

Which restore setting do I use?

The general rule is that unless both the mouse *and* the driver are *both* IntelliMouse compatible then you need to restore the mouse as 'PS/2'. An IntelliMouse can operate in either mode, whereas a PS/2 mouse cannot.

Recognising an IntelliMouse-style mouse

The IntelliMouse format was introduced to support, among other features, the scroll wheel function. If the mouse has a scroll wheel, then it is likely to support the IntelliMouse format. If it is a Microsoft-branded mouse, then it will usually state that it is an IntelliMouse on its underside label.

Recognising an IntelliMouse driver

Before hot plugging to the AdderLink IP (or afterwards using only keyboard control), access the Windows Control Panel of the computer and select either the *Mouse* option (on Windows NT, 2000 and XP) or the *System* option (on Windows 95, 98, ME). Look for the name of the driver, which will usually include the words *PS/2* or *IntelliMouse*.

To restore mouse operation when hot plugging:

- 1 Using a KVM cable set, carefully make the keyboard, monitor and mouse connections between the host computer and the ports collectively labelled COMPUTER/KVM SWITCH on the AdderLink IP.
- 2 Using a keyboard and monitor directly connected to the AdderLink IP, log on and then press **Ctrl** **Alt** **C** to view the options menu. [More about hotkeys](#)
- 3 Select the 'Restore mouse functions' option to display:

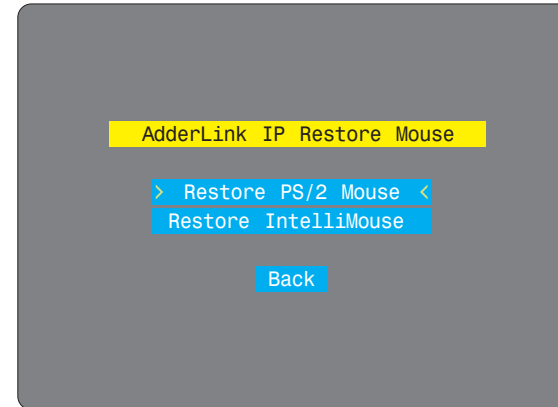

- 4 Select one of the following options:
 - *Restore Standard Mouse* – if PS/2 mode is required, or
 - *Restore IntelliMouse* – if IntelliMouse mode is required.
- 5 Select the 'Return to host' option.
- 6 Move the mouse a short distance and check for appropriate on-screen cursor movement. If the mouse cursor darts erratically around the screen, then cease moving the mouse. This is an indication that the chosen restore function is incorrect. Try again using the other restore function.

Note: The restore functions predict the likely mouse resolution settings but may not restore the exact speed or sensitivity settings that were originally set.

Resetting the configuration

The AdderLink IP asks for an unknown admin password

This may occur if the AdderLink IP has been previously configured. If the existing admin password cannot be discovered, then your only recourse is to perform a factory reset.

To invoke a configuration reset by switch

- 1 Remove power from the AdderLink IP unit.
- 2 At the rear of the AdderLink IP, adjacent to the power input socket, click mini switch 1 to its ON (down) position.
- 3 Re-apply power to the AdderLink IP. On the locally connected monitor you should see a Maintenance menu:

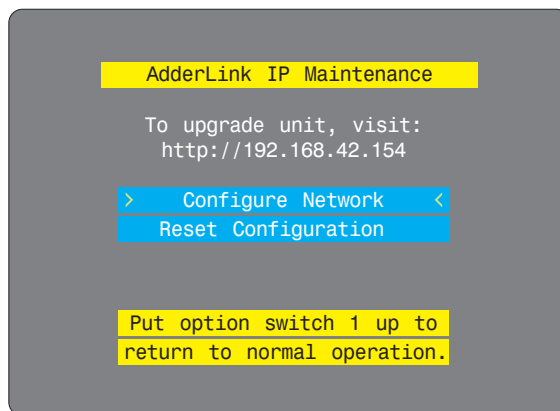

- 4 Select the 'Reset configuration' option. A warning screen will be displayed. Select the RESET option and press

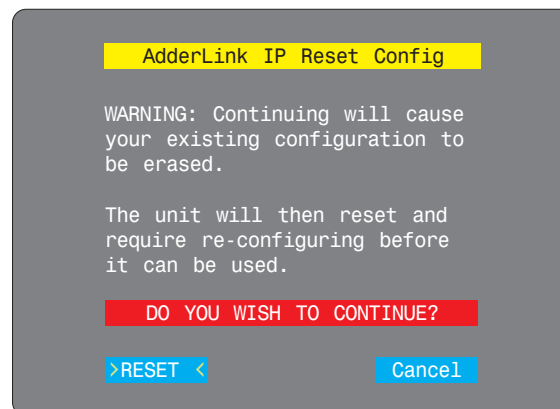

- 5 Remove power, return the mini switch 1 to its OFF position and then re-apply power. The locally connected monitor should display the first screen of the [initial configuration sequence](#).

The AdderLink IP does not display the configuration sequence

If the AdderLink IP has been previously configured it may not automatically display the first of the setup screens. In this case you have two options, either:

- Access the Unit, Network and Serial [configuration screens separately](#), or
- Reset the configuration:

To invoke a configuration reset by main menu

- 1 Using the locally connected keyboard and screen, log on as the admin user.
- 2 Select the 'Configuration' option.

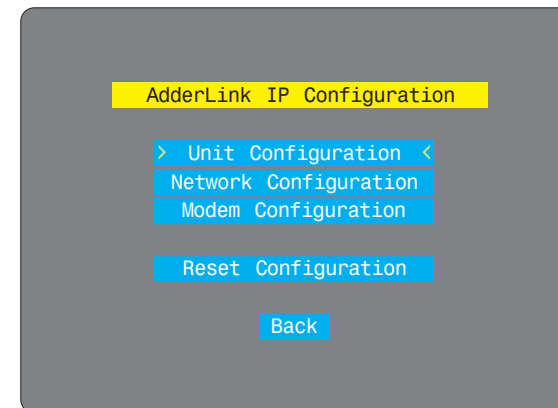

- 3 Highlight the 'Reset configuration' option and press . A warning screen will be displayed, select the RESET option and press .

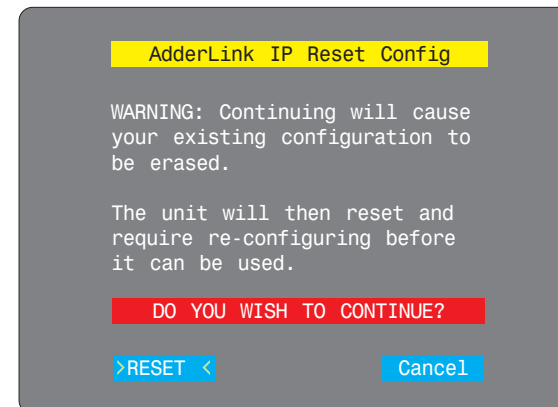

- 4 The AdderLink IP will reset and then display the first of the four [initial configuration screens](#).



Part 2 – Remote configuration



The second part of the configuration requires you to log into the AdderLink IP from a system via either a network connection or a dial-up connection (via modem or ISDN). In either case there are two types of access applications that you can use:

- The VNC viewer – a small application supplied on the CD-ROM or downloadable from the Adder and RealVNC websites or even downloadable from the AdderLink IP itself.

or

- A standard browser that supports Java – As soon as a web browser makes contact, the AdderLink IP downloads a Java application to it. This allows a viewer window to be opened and operation to commence just as it would with the VNC viewer application.

To perform the remote configuration

- 1 Use either the VNC viewer or a standard web browser to make remote contact with the AdderLink IP – see [Connecting to the AdderLink IP](#) for more details.
- 2 If the username entry is not blanked out, enter 'admin'. Then enter the password that was set during the local configuration stage (if no password was set, then just press ) . Once logged in, the AdderLink IP will show the video output from the host system (if one is connected), or otherwise a 'No Signal' message.
- 3 Click the Configure button in the top right hand corner of the window to display the configuration menu 

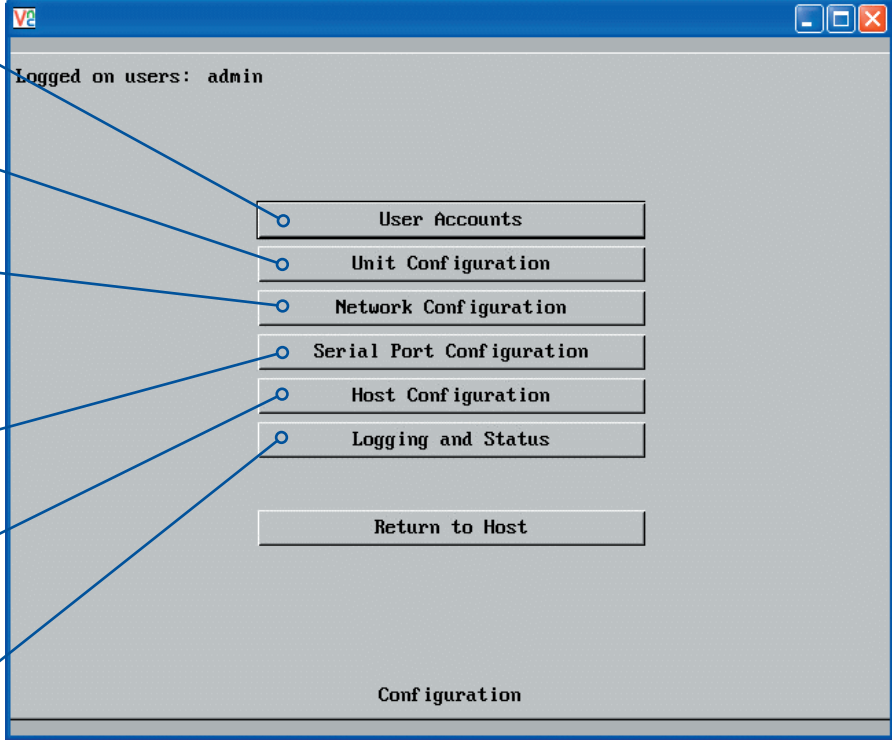

User accounts
Allows you to create and manage up to sixteen separate user accounts, each with separate access permissions.

Unit configuration
Allows you to alter both basic and fundamental settings within the AdderLink IP.

Network configuration
Here you can alter any of the existing network settings plus you can take advantage of the IP access control feature that lets you to specifically include or exclude certain addresses or networks.

Serial port configuration
Lets you setup or alter the details concerning the modem and power control serial ports.

Host configuration
Allows you to configure user access, hot key switching and power control codes for up to 32 host systems that may be connected to the AdderLink IP via KVM switch units.

Logging and status
Provides various details about the user activity on the AdderLink IP.

Shaded items signify options that are not available at the local configuration stage.

Many of the options within the configuration menu duplicate those that were set (or are available) in the local configuration. However, there are numerous other settings that are only available here.

For more information about each menu option, please see [Appendix 5 - Remote configuration menus](#) in the 'Further information' chapter.

Networking issues

Thanks to its robust security the AdderLink IP offers you great flexibility in how it integrates into an existing network structure. The AdderLink IP is designed to reside either on an internal network, behind a firewall/router or alternatively with its own direct Internet connection.

Positioning AdderLink IP in the network

Every network setup is different and great care needs to be taken when introducing a powerful device such as the AdderLink IP into an existing configuration. A common cause of potential problems can be in clashes with firewall configurations. For this reason the AdderLink IP is designed to be intelligent, flexible and secure. With the minimum of effort the AdderLink IP can reside either behind the firewall or alongside with its own separate Internet connection.

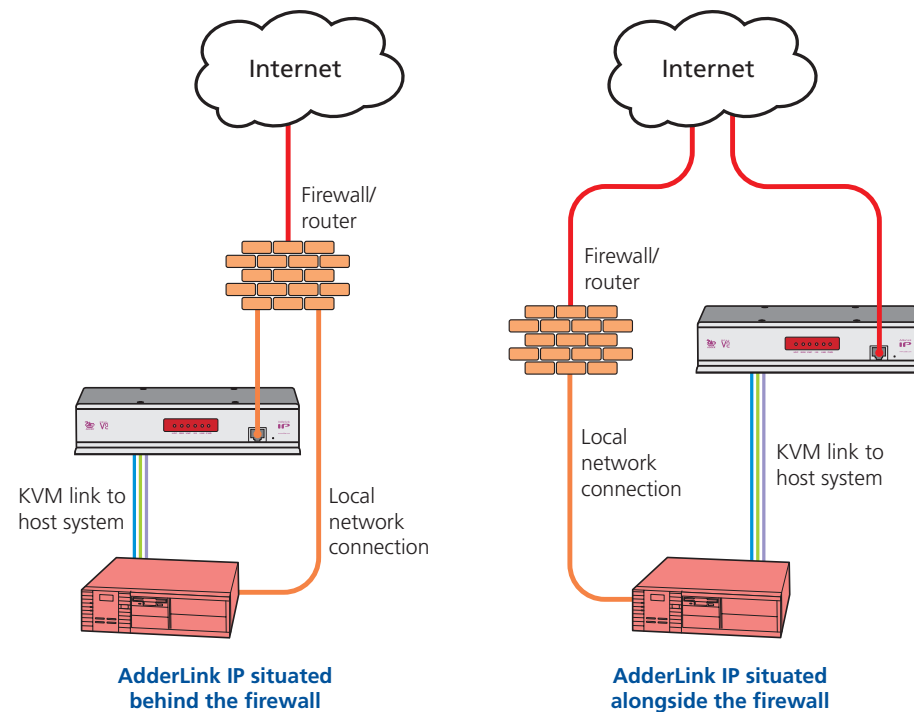

IMPORTANT: When the AdderLink IP is accessible from the public Internet or dial up connection, you must ensure that sufficient [security measures](#) are employed.

Placing AdderLink IP behind a router or firewall

A possible point of contention between the AdderLink IP and a firewall can occasionally arise over the use of IP ports. Every port through the firewall represents a potential point of attack from outside and so it is advisable to minimise the number of open ports. The AdderLink IP usually uses two separate port numbers, however, these are easily changeable and can even be combined into a single port.

IMPORTANT: The correct configuration of routers and firewalls requires advanced networking skills and intimate knowledge of the particular network. Adder Technology cannot provide specific advice on how to configure your network devices and strongly recommend that such tasks are carried out by a qualified professional.

Port settings

As standard, the AdderLink IP uses two [ports](#) to support its two types of viewer:

- **Port 80** for users making contact with a web browser, and
- **Port 5900** for those using the VNC viewer.

When these port numbers are used, VNC viewers and web browsers will locate the AdderLink IP correctly using only its network address. The firewall/router must be informed to transfer traffic, requesting these port numbers, through to the AdderLink IP.

When a web server is also on the local network

Port 80 is the standard port used by web (HTTP) servers. If the AdderLink IP is situated within a local network that also includes a web server or any other device serving port 80 then, if you want to use the web browser interface from outside the local network environment, the HTTP port number of the AdderLink IP must be changed.

When you change the HTTP port to anything other than 80, then each remote browser user will need to specify the port address as well as the IP address. For instance, if you set the HTTP port to '8000' and the IP address is '192.168.47.10' then browser users will need to enter:

`http://192.168.47.10:8000`

(Note the single colon that separates the IP address and the port number).

The firewall/router would also need to be informed to transfer all traffic to the new port number through to the AdderLink IP.

If you need to change the VNC port number

If you change the VNC port to anything other than 5900, then each VNC viewer user will need to specify the port address as well as the IP address. For instance, if you set the VNC port to '11590' and the IP address is '192.168.47.10' then VNC viewer users will need to enter:

`192.168.47.10::11590`

(Note the *double* colons that separate the IP address and port number).

The firewall/router would also need to be informed to transfer all traffic to the new port number through to the AdderLink IP.



Addressing

When the AdderLink IP is situated within the local network, you will need to give it an appropriate local IP address and IP network mask. This is achieved most easily using the DHCP server option which will apply these details automatically. If a DHCP server is not available on the network, then these details need to be applied manually in accordance with the network administrator.

The firewall/router must then be informed to route incoming requests to port 5900 or port 80 (if available) through to the local address being used by the AdderLink IP.

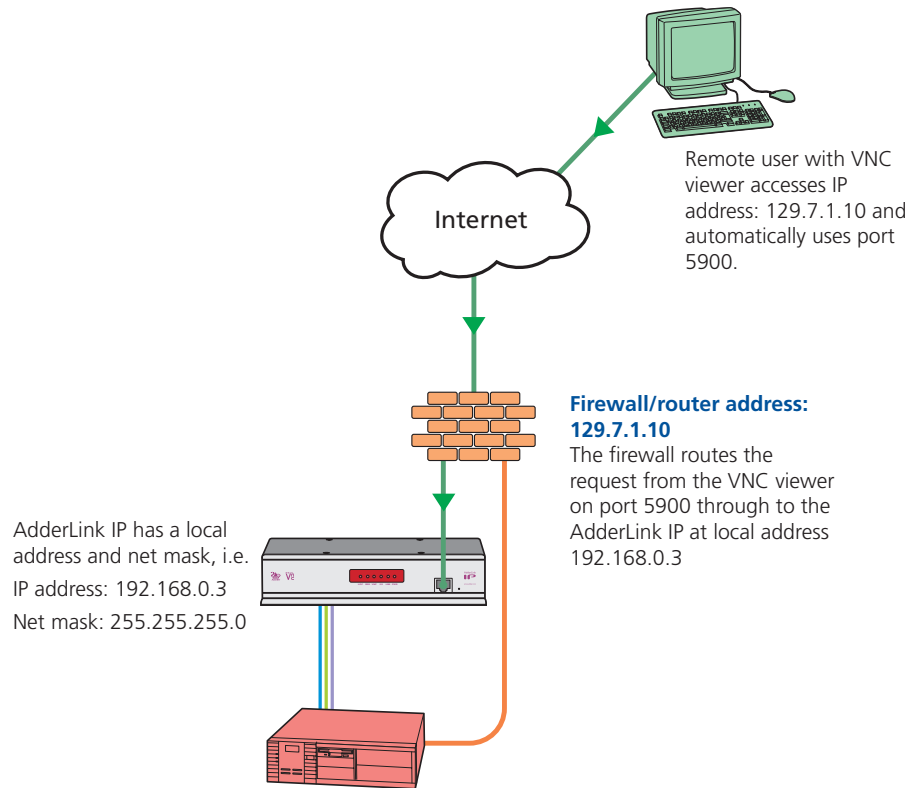

To discover a DHCP-allocated IP address

Once a DHCP server has allocated an IP address, you will need to know it in order to access the AdderLink IP via a network connection. To discover the allocated IP address:

- 1 In either the [local](#) or [remote](#) Network configuration screens, set the 'Use DHCP' option to 'Yes' and select 'Save'. Once the page is saved, the AdderLink IP will contact the DHCP server and obtain a new address.
- 2 Re-enter the same 'Network configuration' screen where the new IP address and network mask should be displayed.

DNS addressing

As with any other network device, you can arrange for your AdderLink IP to be accessible using a name, rather than an IP address. This can be achieved in two main ways:

- For small networks that do not have a DNS (Domain Name System) server, edit the 'hosts' files on the appropriate remote systems. Using the hosts file, you can manually link the AdderLink IP's address to the required name.
- For larger networks, declare the IP address and required name to the DNS server of your local network.

The actual steps required to achieve either of these options are beyond the scope of this document.

Placing AdderLink IP alongside the firewall

AdderLink IP is built from the ground-up to be secure. It employs a sophisticated 128bit public/private key system that has been rigorously analysed and found to be highly secure (a security white paper is available upon request from Adder Technology Ltd). Therefore, you can position the AdderLink IP alongside the firewall and control hosts that are also IP connected within the local network.

IMPORTANT: If you make the AdderLink IP accessible from the public Internet or from a modem, care should be taken to ensure that the maximum security available is activated. You are strongly advised to enable encryption and use strong password. Security may be further improved by restricting client IP addresses, using a non-standard port number for access or limiting remote access to dial up connections only.

Ensuring sufficient security

The security capabilities offered by the AdderLink IP are only truly effective when they are correctly used. An open or weak password or unencrypted link can cause security loopholes and opportunities for potential intruders. For network links in general and direct Internet connections in particular, you should carefully consider and implement the following:

- Ensure that encryption is enabled.
By [local configuration](#) or by [remote configuration](#).
- Ensure that you have selected secure passwords with at least 8 characters and a mixture of upper and lower case and numeric characters.
By [remote configuration](#).
- Reserve the admin password for administration use only and use a non-admin user profile for day-to-day access.
- Use the latest Secure VNC viewer (this has more in-built security than is available with the Java viewer). To [download the viewer](#).
- Use non-standard [port numbers](#).
- Restrict the range of IP addresses that are allowed to access the AdderLink IP to only those that you will need to use. To [restrict IP access](#).
- Do NOT Force VNC protocol 3.3. [Remote configuration](#).
- Add a further level of inherent security by restricting access only via modem or ISDN dialup.
- Ensure that the computer accessing the AdderLink is clean of viruses and spyware and has up-to-date firewall and anti-virus software loaded that is appropriately configured.
- Avoid accessing the AdderLink from public computers.

Security can be further improved by using the following suggestions:

- Use a KVM switch with On-Screen-Display driven security access and an auto-logout (after inactivity) feature to provide a second level of security. KVM switches such as the AdderView Matrix or SmartView XPro are recommended.
- Place the AdderLink IP behind a firewall and use port the numbers to route the VNC network traffic to an internal IP address.
- Review the activity log from time to time to check for unauthorized use.
- Lock your server consoles after they have been used.

A security white paper that gives further details is available upon request from Adder Technology Limited.

Ports

In this configuration there should be no constraints on the port numbers because the AdderLink IP will probably be the only device at that IP address. Therefore, maintain the HTTP port as 80 and the VNC port as 5900.

Addressing

When the AdderLink IP is situated alongside the firewall, it will require a public static IP address (i.e. one provided by your Internet service provider).

More addressing information:

[Discover DHCP-allocated addresses](#)

[DNS addressing](#)

Power switching configuration

Power switch configuration comprises two main steps:

- Configure the COM2 serial port to the same speed as used by the power switch box(es) - see [Serial port configuration](#) for details.
- Configure power ON and OFF strings for each relevant host computer.

For each power port there needs to be a valid 'Power ON string' and similarly an appropriate 'Power OFF string'. In each case, the strings are a short sequence of characters that combine a port address and a power on or off value.

If a particular computer has more than one power input (and thus requires an equivalent number of power ports to control them), collections of strings can be combined to switch all of the required ports together as a group.

To configure the power sequences for each host computer

- 1 Using VNC viewer or a browser, log on as the 'admin' user.
- 2 Click the 'Configure' button in the top right corner.
- 3 Click the 'Host configuration' option.
- 4 Click one of the 32 host entry slots to display a Host configuration dialog:

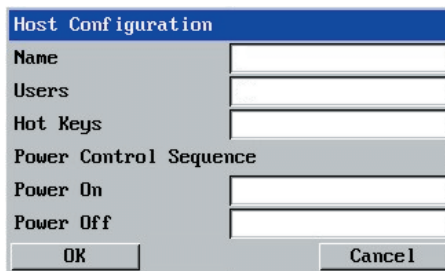

- 5 If necessary, configure other parameters (Name, Users, Hot Keys - [MORE](#)).
- 6 Enter the **Power control sequences** in the Power On and Power Off fields ⇒
- 7 Click OK to close the dialog and then click the Save button in the main Host Configuration window to store the details.

Power control sequences

Note: The settings given below are for the EPS-S8 power switch - other power switches may require different settings. Please refer to your power switch documentation for details about codes required by other power switches.

The structure of each power sequence (OFF and ON) is as follows:

$P_{xy}=z\backslash0D$

Where:

- x** is the switch box number,
- y** is the power port number,
- z** is '0' for OFF or '1' for ON, and
- \0D** represents Enter (or Carriage return).

Example 1

To switch ON port 5 of switch box 2, the code would be as follows:

- Power sequence: $P25=1\backslash0D$

Example 2

To switch OFF port 8 of switch box 3, the code would be as follows:

- Power sequence: $P38=0\backslash0D$

For details about operating this feature, see [Power control](#) within the Operation chapter.

To control two or more ports simultaneously

You can control up to four power ports using a single sequence. This is done using the same command structure as shown above, plus a delay command, for each port. Immediately following a port command, insert the characters '*' before the next port command, and so on up to four ports. For instance, to switch on ports 1 and 2 in the first power switch, the command line would be:

$P11=1\backslash0D\backslash*P12=1\backslash0D$



Performing a flash upgrade

AdderLink IP is fully reconfigurable via flash upgrade

To perform a flash upgrade

- 1 Using a [remote connection](#), log on as the admin user and access the [Unit configuration page](#) to determine the current firmware version of the AdderLink IP unit.
- 2 Visit the Adder website, locate the downloads section and select an AdderLink IP firmware revision that is later than the one currently installed.
- 3 Power down the AdderLink IP unit. At the rear of the unit, adjacent to the power input socket, click mini switch 1 to its ON (down) position.
- 4 Re-apply power to the AdderLink IP. On the locally connected monitor you should see a Maintenance menu:

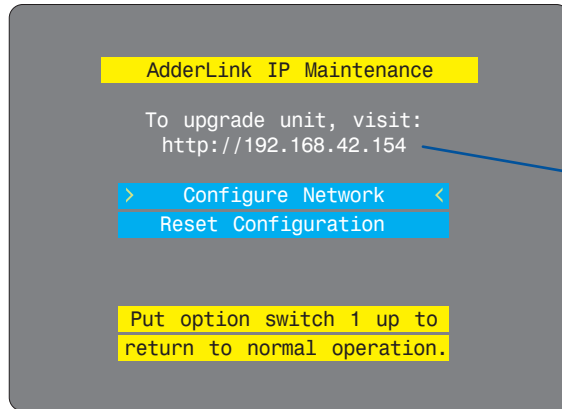

Current network address of the AdderLink IP

The Maintenance menu should display the current network address of the AdderLink IP.

- If the current network address is incorrect then select the 'Configure network' option to change it:
- 5 Use the web browser (not the VNC viewer) on the previously used remote system, connect to the network address shown in the local Maintenance menu.
 - 6 Follow the on screen instructions to upload the firmware file (previously obtained from the Adder site) to the AdderLink IP.
IMPORTANT: Wait until the upgrade is complete.
 - 7 When the upload is complete and confirmed on screen, log off the remote system and then power down the AdderLink IP.
 - 8 At the rear of the unit, return the mini switch 1 to its OFF position and then re-apply power.

Configure network option

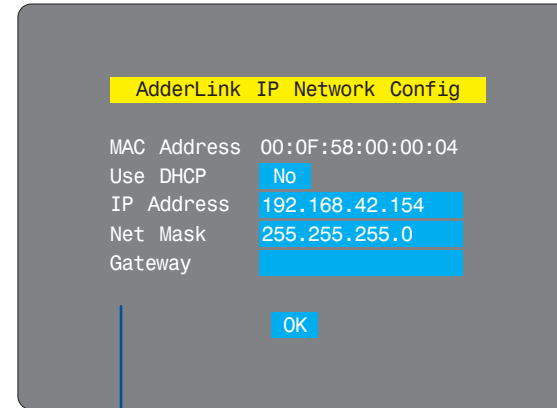

MAC address

Media Access Control address – this is the unique and unchangeable code that was hard coded within your AdderLink IP unit when it was built. It consists of six 2-digit hexadecimal (base 16) numbers separated by colons. A section of the MAC address identifies Adder Technology as the manufacturer, while the remainder is effectively the unique electronic serial number of your particular unit.

Use DHCP

When this option is selected, your AdderLink IP will attempt to locate a DHCP server on the network. If such a server is located, it will [supply three things](#) to the AdderLink IP: an IP address, an IP network mask (also known as a Subnet mask) and a Gateway address.

IP address

This is the identity of the AdderLink IP within a network. It can either be entered manually or configured automatically using the DHCP option. When the DHCP option is enabled, this entry is greyed out.

Net mask

Also often called the 'subnet-mask', this value is used alongside the IP address to help define a smaller collection (or subnet) of devices on a network. In this way a distinction is made between locally connected devices and ones that are reachable elsewhere, such as on the wider Internet.

Gateway

This is the address of the device that links the local network (to which the AdderLink IP is connected) to another network such as the Internet. Usually this is a network switch or router and it will be used whenever a device to be contacted lies outside the local network.



Operation



Connecting to the AdderLink IP

The AdderLink IP offers you three ways to connect:

- Local connection,
- [Remote connection](#) by network link,
- [Remote connection](#) by direct dial up (modem or ISDN) link,

...and two types of viewer:

- VNC viewer,
- Standard web browser.

Local connection

The keyboard, video monitor and mouse connected directly to the AdderLink IP offer password protected access to the host computer(s).

To make a local connection:

- 1 Using the keyboard connected directly to the AdderLink IP, press any key to exit the screensaver and display the logon prompt.

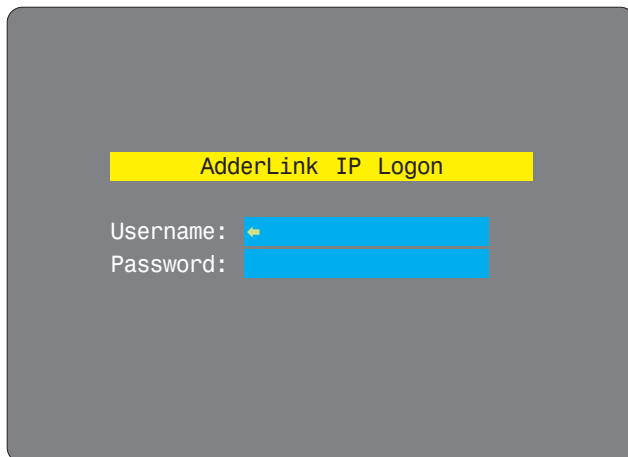

- 2 Enter your username and password. Providing you have the correct permissions, the screen will display the currently selected host computer.

To view the local control menu

- 1 Press and hold the hotkeys (usually **Ctrl** and **Alt**), then press **C** and finally release all three keys.

*Note: The **Ctrl** and **Alt** keys when pressed in combination are called 'hotkeys' and they signal to the AdderLink IP that you wish to control it, rather than the host computer. However, if these particular hotkeys clash with another device or program, then your administrator may change them to a different combination. If the **Ctrl Alt C** combination fails to work, then please contact the system administrator for details.*

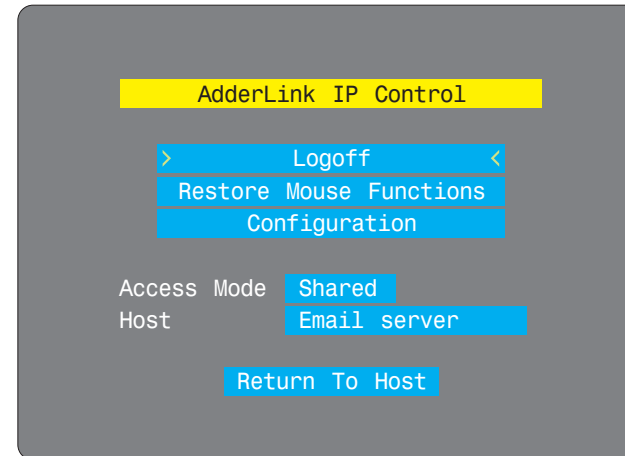

The local control menu contains numerous options, the most useful of which are:

- **Access mode** - Allows you to select a 'Private' mode in order to prevent other logged on users from viewing your actions on the host computer. Use **↔** and **↔** to change between modes.
Note: For the courtesy of other users, this mode should be used sparingly. The admin user has the ability to overrule the private setting.
- **Host** - Where more than one host computer is available via the AdderLink IP, this option allows you to easily switch between them. Use **↔** and **↔** to change between host computers.
- **Return to host** - Quits the control menu and displays the host computer screen.

Local connection (continued)

To avoid the 'hall of mirrors' effect

IMPORTANT: Never configure a system so that your viewer is viewing itself.

When controlling a host computer using the locally connected keyboard, video monitor and mouse, it is possible to use the VNC viewer or a browser (if the host computer is networked) to create a remote link back to itself. This will set up a 'hall of mirrors' effect, where the computer is viewing itself into infinity.

While technically possible, the AdderLink IP unit is not designed to withstand this treatment and could sustain damage.

Remote connections

From a remote system, you connect to the AdderLink IP using a viewer and a link. There are two types of viewer and two types of link, which can be used in any combination.

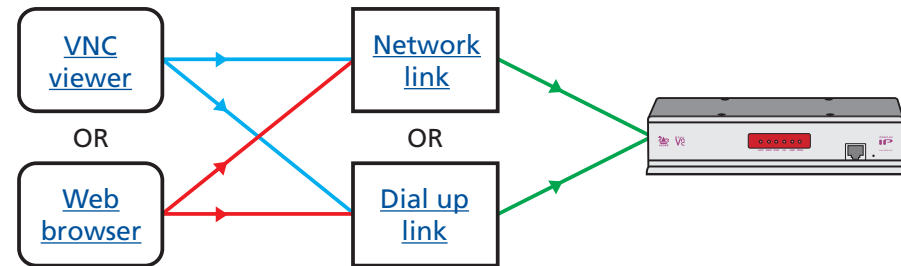

INSTALLATION

CONFIGURATION

OPERATION

FURTHER INFORMATION

INDEX

Remote connection by VNC viewer

The VNC viewer is a compact application that runs on your remote system and allows you to view and use the AdderLink IP and its host computer(s). VNC viewer is readily available from a number of different sources:

- from the AdderLink IP installation CD
- from the [AdderLink IP itself](#)
- from the [Adder Technology website](#)
- from the [RealVNC website](#)

To connect using the VNC viewer

- 1 Locate and select the VNC viewer icon ⇨ 

 - [If you are using a dial up link.](#)

A connection details dialog will be displayed:

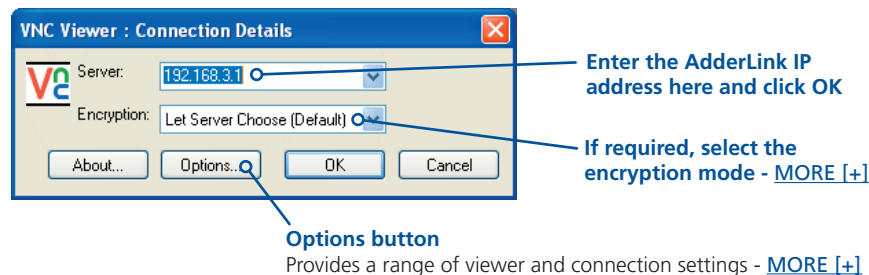

- 2 In the 'Server:' entry, type the address of the AdderLink IP as follows:

v.w.x.y

where v.w.x.y is the IP network address, for example 192.168.0.3

- [If you have been asked to also enter a port number.](#)

- 3 Click the OK button. Depending on the options selected, you may need to confirm certain items. A connection attempt will be made and if successful, an authentication dialog will be displayed:

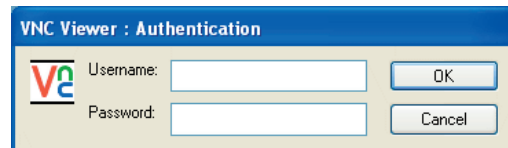

- 4 Enter your username and password. The [viewer window](#) should now open and show the current host computer. *Note: If the Username entry is blanked out then only admin user account is currently defined and only a password is required.*

Remote connection by Web browser

You can use a standard Web browser ([supported versions](#)) to gain access to the AdderLink IP and its host computer(s). As soon as you make contact with the AdderLink IP it will begin downloading a small Java application to your browser, which will be used only for the duration of your connection.

To connect using your Web browser

- 1 Launch your standard Web browser as usual.
 - [If you are using a dial up link.](#)
- 2 In the Address section, type the address of the AdderLink IP as follows:

http://v.w.x.y

where v.w.x.y is the IP network address, for example 192.168.0.3

- [If you have been asked to also enter a port number.](#)

- 3 Press . A connection attempt will be made. In the browser window, select the 'Connect using built-in Java VNC viewer' option to download a small application that will temporarily empower your browser (on slow connections the application download can take several tens of seconds to complete). Once complete, a connection details dialog will be displayed:

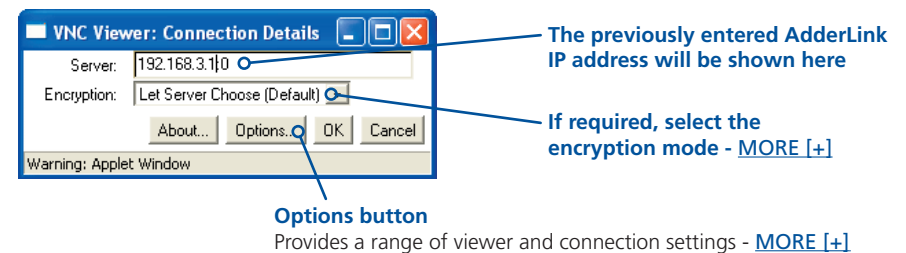

- 4 Make any necessary option/encryption changes and click the OK button to proceed. Depending on the options selected, you may need to confirm certain items.
- 5 A second connection attempt will be made and if successful, an authentication dialog will be displayed:

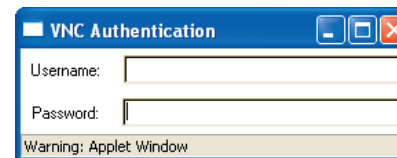

- 6 Enter your username and password. The [viewer window](#) should now open and show the current host computer. *Note: If the Username entry is blanked out then only admin user account is currently defined and only a password is required.*



Using the viewer window

The viewer window gives you the ability to view and control the AdderLink IP and its host computer(s). Its operation is almost identical regardless of whether you used the VNC viewer or your Web browser to display it.

The menu bar

The viewer window presents a menu bar similar to that shown below. Certain items within the toolbar are displayed depending upon your access permissions and/or the AdderLink IP configuration.

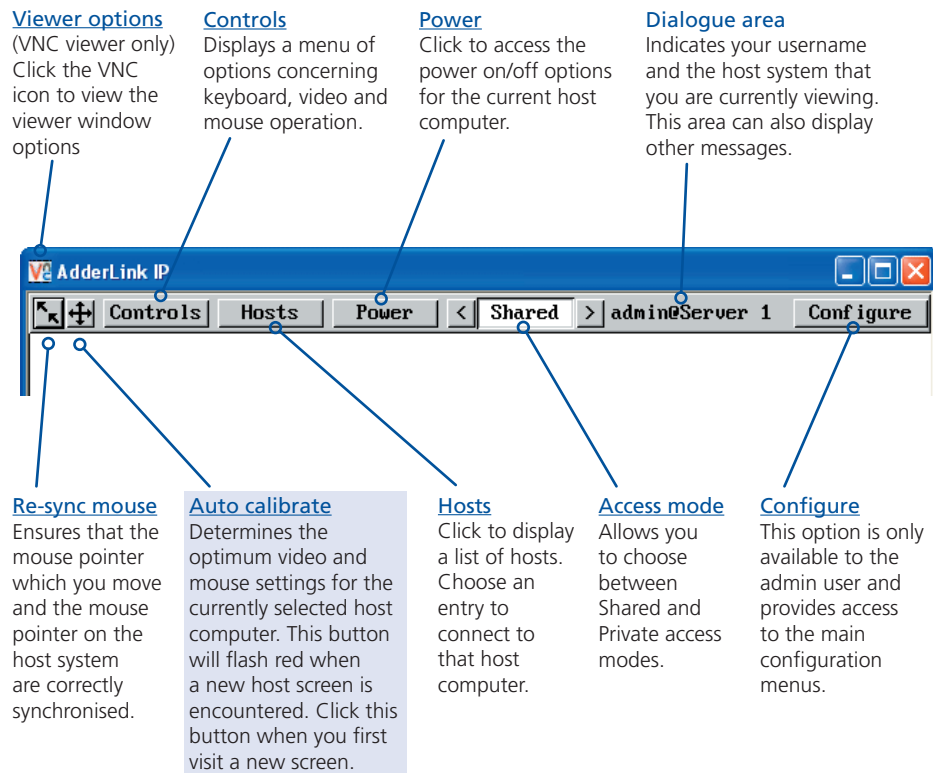

When using the viewer window

What is the best screen resolution to use?

The best resolution for your computer is one that is larger than the screen of the host computer that you are viewing. This will allow you to see everything without scrolling around, as described next.

How do I navigate around a larger screen?

If the screen that you are viewing has a larger resolution than your viewing window you will need to scroll around to see all items. The viewer window allows you to 'bump scroll' (only in full screen mode). This means that when your mouse cursor bumps against the edge of the screen, the screen image will scroll across automatically.

How do I escape from full screen mode?

Press the F8 button. This button is changeable but is most often set to F8.

Why is the button flashing red?

This happens when a new host screen is viewed (that has not been viewed before). Click the  button to perform an auto calibration for the screen and the mouse. See [Auto calibrate](#) for important information about this feature.

How do I change between host computers?

The best way to change between host computers is to click the 'Hosts' button and then select the required computer by name. See [Host selection](#).

How do I remove traces of moved items from the screen?

When you move an item or window across the screen, sometimes it can leave unsightly trails. These are called *artifacts* and can be particularly prevalent when the connection speed is low. To remove artifacts, click the 'Controls' button and select the 'Refresh screen' option. See [Controls](#).

How do I make the most of a slow connection?

The VNC viewer is slightly better suited to slower connections than the browser viewer because it offers more options. Click the [Options](#) button of the VNC viewer when entering the AdderLink IP address during log on.

Adjust the Threshold setting

Ensure that the video [Threshold setting](#) is set higher than the automatic setting suggests. Tweak this setting manually to ensure the best setting.

Fewer colours

Select the [Low \(64 colours\)](#) mode. The Very low option offers hardly any improvement and looks a lot worse.

Rate limit mouse events

When selected, this mode greatly reduces the mouse movement data that are sent to the host computer. When you move the local mouse, the remote cursor will catch up roughly once per second.

Mouse pointers

Both viewers use a double mouse cursor to help overcome any delays caused by slow connections. When you move your mouse you will see two mouse cursors, a local one that responds immediately to your movements and a second, slower moving, cursor that represents the current mouse position at the host.

For the browser viewer, the local cursor is a typical arrow:

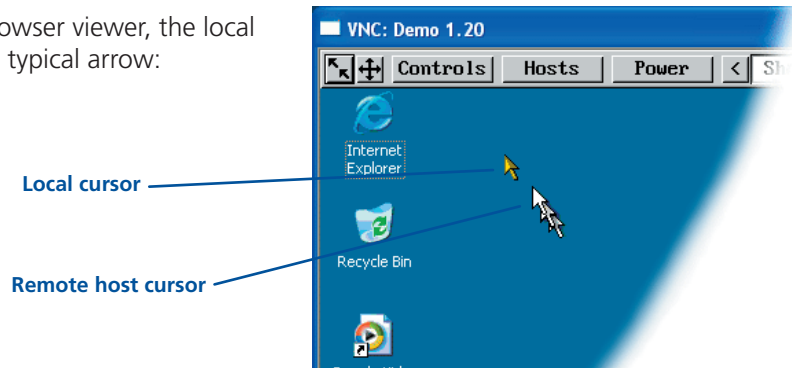

For the VNC viewer, the local cursor is a dot:

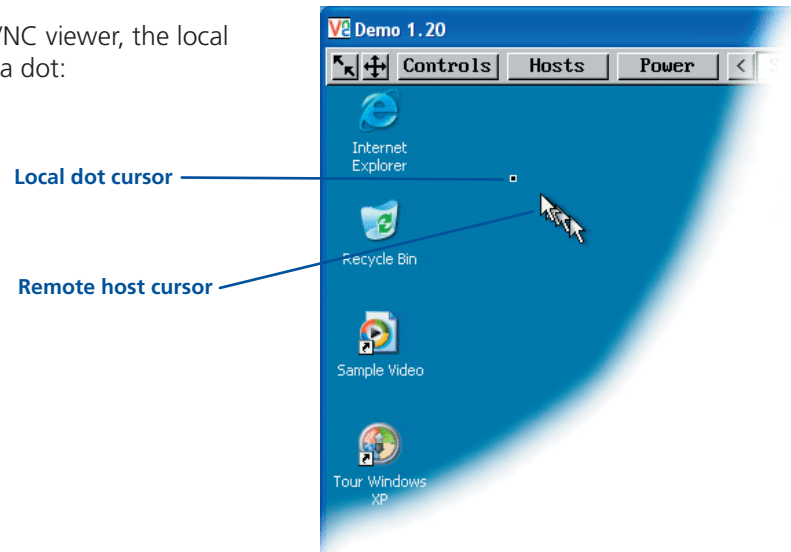

Host selection

The Hosts button on the menu bar provides the quickest and most efficient way to switch between host computers. This is because the button is close at hand, but also because the screen calibration details for each host are reused when this method of switching is used. The alternative is to use KVM switch hotkey combinations or the KVM switch on screen display.

Note: The Hosts button is displayed only when the switching details for two or more computers have been declared within the configuration section by the admin user.

To select a host

- 1 Click the Hosts button to display a list of computers.
- 2 Click the required computer name to view and control it.

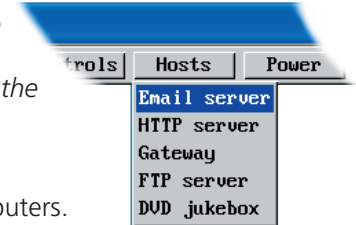

Configure

This option is displayed only when you are logged on as the 'admin' user. When selected it provides access to a wide range of AdderLink IP settings.

See [Appendix 5 - Remote configuration menus](#) for more details.

Auto calibrate

When you visit a host computer for the very first time, your viewer needs to determine the optimum video and mouse settings for that particular computer. The button will remind you to click by flashing red when it encounters a new computer screen. Performing this step is important because it can help to decrease unnecessary video information being sent across the link, thus improving overall performance.

Once this has been done, providing you use the 'Hosts' button to switch between host computers, the video settings for each machine will be re-used.

Note: When performing an auto calibration, ensure that the screen image is static (no moving images) and also that there are no on-screen displays generated by KVM switches (such as host names or menus). This is because they may confuse the calculation and can result in a lower overall performance level. For the mouse calibration part, ensure that there are no application windows located around the upper left corner of the screen. This is because as the mouse calibration takes place, the cursor may change (to match the application as it skims across the window) and this may confuse the calculation. Also ensure that the host system does not have the mouse cursor trails option enabled.

To auto calibrate the screen and mouse

- 1 Use the Hosts button to select the required computer.
- 2 Click the  button and then click OK in the subsequent pop-up message.
The screen will appear to freeze for approximately 10 to 60 seconds as the necessary calculations are made. Operation will return as soon as the calculations are complete.

Re-synchronise mouse

If you find that your local mouse pointer and that of the host are not correctly synchronised, use this feature to re-align their movements. This operation is also selectable from the Controls menu.

To re-synchronise the mouse

- 1 Use the Hosts button to select the required computer.
- 2 Click the  button and then click OK in the subsequent pop-up message.
Note: If you find that this doesn't work, you may need to perform a mouse calibration again.

Access mode - shared/private

Up to five users can be simultaneously logged-on (four remote users plus one local user) and during normal operation, all are able to see the same view of the currently selected host. If you need to perform a sensitive task that should not be viewed by other users, you can change the access mode to Private. This action blanks the viewer window for all other logged on users.

Note: For the courtesy of other users, this mode should be used sparingly. The admin user has the ability to overrule the private setting.

To change the access mode

- 1 Click one of the arrow buttons adjacent to the Shared/Private indicator.



Power control

When configured (and where you have access rights) this option allows you to control the mains power input to the currently selected host computer.

Note: This option is generally used to power cycle remote systems that have failed to respond. Before switching a system off, ensure that all attempts have first been made to power it down through normal means.

To switch a system on or off

- 1 Use the Hosts button to select the required computer.
- 2 Click the Power button and then select the Switch on or Switch off option, as appropriate.

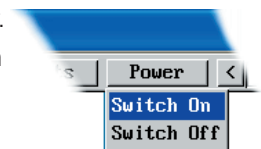

Controls

When clicked, this button reveals a menu of options concerned with keyboard, video and mouse operation.

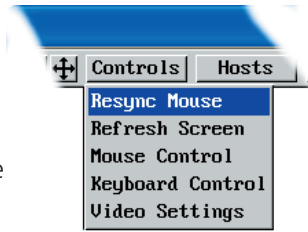

Resync mouse

This option has the same effect as the button on the menu bar and resynchronises the local and remote mouse pointers.

Refresh screen

This option refreshes the whole screen image to remove any artifacts from moved screen items. This is useful when using very low refresh rates on slow speed communication links.

Mouse control

This option displays a mouse control dialog and is useful when the remote cursor is failing to respond correctly to your mouse movements, even after using the Resync mouse option.

The mouse control dialog allows you to control the remote mouse cursor using a selection of buttons that you click with your local mouse.

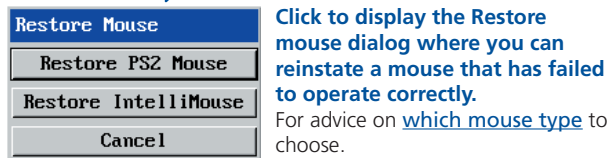
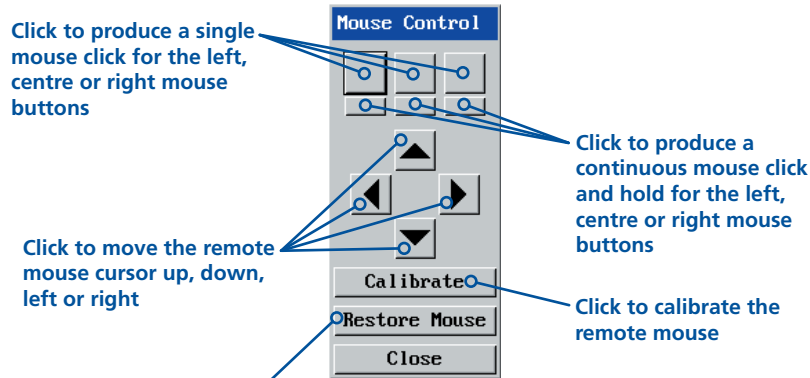

Click to display the Restore mouse dialog where you can reinstate a mouse that has failed to operate correctly.
For advice on [which mouse type](#) to choose.

Keyboard control

This option displays a keyboard control dialog and is useful for sending keyboard combinations (to the host) that are needed regularly or that are trapped by the AdderLink IP.

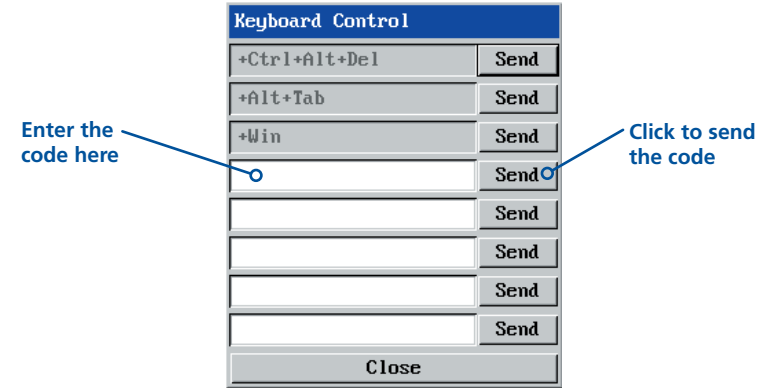

When entering codes:

- + means press and hold down the named key,
- means release the named key.

It is automatically assumed that all keys specified will be released at the end, so there is need to specify -Ctrl or -Alt if these keys are to be released together.

See [Appendix 8](#) for a list of key sequence codes that can be used.

Examples:

- 'Ctrl + Alt 12' would be expressed as: +Ctrl+ Alt+1-1+2
- +N means press the 'N' key
- +Scroll means press the Scroll lock key
- +Space means press the space key

Video settings

see [next page](#)

Video settings

This dialog provides access to all of the key video settings that determine image quality and link performance.

Phase

The phase setting adjusts the alignment of the host video output and the remote system video display to achieve the sharpest image.

Horizontal position

Determines the horizontal position of the host screen image within the viewer window.

Vertical position

Determines the vertical position of the host screen image within the viewer window.

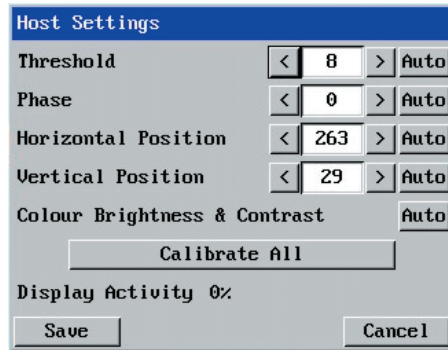

Colour, brightness & contrast

Provides an automatic setting button to optimise these three important video constituents for the current host and connection speed.

Calibrate all

Click to determine the optimum settings for all aspects of video the video connection from the host system.

Threshold

The threshold is effectively a noise filter that differentiates between valid video signals and background noise or interference. This has the effect of reducing unnecessary video signals between the AdderLink IP and the remote system, thus improving performance.

Display activity

Indicates the level of video activity currently in progress.

Setting the Threshold manually

Occasionally it can be useful to manually adjust the Threshold setting, such as when there is a KVM switch OSD banner that cannot be easily removed from the display.

- 1 Use the 'Calibrate all' function to ensure that all other settings are optimised.
- 2 Click the Threshold left arrow button to decrement the setting by one and observe the Display activity indicator.
- 3 Repeat step 2 until the Display activity indicator suddenly rises to a much higher level (i.e. 50%). This will mean that you have reached the noise boundary. At this point, increment the Threshold value by 2 or 3 points to achieve an optimum setting.

All settings can be individually subjected to an auto configuration (click the appropriate 'Auto' button) and most can also be manually adjusted.

Use the 'Calibrate all' button to automatically determine the optimum settings for all items.

Note: Before using the Calibrate all option, ensure that there are no on-screen display elements generated by any connected KVM switch (such as a host name label or menu). Due to the differing video rates of these items compared to the video image from the host itself this can confuse the calibration process into giving a much higher Threshold rate than is necessary, thus worsening the screen artefacts.

Connecting via dial up (modem or ISDN) link

When you use a modem or ISDN link to make the connection, the AdderLink IP uses standard network protocols to create a private two-device network. This approach ensures consistency and allows you to use exactly the same VNC viewer or browser to view the hosts systems. This is achieved using PPP (Point to Point Protocol) and means that you need to use a dial-up networking method to initiate the connection. Such software is standard with operating systems such as Windows, Linux and Mac OS.

To initiate a dial up link

- 1 Using a system that has a modem or ISDN adapter installed, locate the dial-up networking option on your system. Please refer to your system documentation for more information.
- 2 Using the dial-up networking option, enter the telephone/ISDN number where the AdderLink IP can be contacted.
- 3 Initiate the call and when the link is made, continue with either the standard [VNC viewer](#) or [browser connection](#).

Note: For the viewer network connection address, you must use the IP address that the admin user has set as the Server address (or PPP server IP address) within the Modem configuration screen.

Downloading VNC viewer from the AdderLink IP

The AdderLink IP has the ability to distribute its own VNC viewer application.

To download the VNC viewer

- 1 Open your Web browser.
- 2 Enter the network address where the AdderLink IP is situated (in the form: <http://192.168.0.3>) and make the link.
- 3 In the opening AdderLink IP screen, click the link that offers to download the secure VNC viewer 'from the unit'.
- 4 Save the download file (vncviewer.exe) to your system.
- 5 Select and run the downloaded file and then connect to the AdderLink IP using the [VNC viewer application](#).

If you need to enter a port number

Usually, when you make a network connection to the AdderLink IP (either using the VNC viewer or a Web browser) you simply enter the IP address, i.e. 192.168.0.3. However, if a special configuration is necessary, then you may be asked to specify a port number as well as the IP address.

[What is a port?](#)

To enter a port number in a Web browser

- 1 Enter the required IP address in the usual Address box, i.e. <http://192.168.0.3>
- 2 At the end of the IP address, add a single colon and then enter the port number (in this example, the required port number is 8000), i.e. <http://192.168.0.3:8000>
- 3 Continue with the standard [Web browser instructions](#).

To enter a port number in VNC viewer

- 1 Enter the required IP address in the usual 'Server' box, i.e. <http://192.168.0.3>
- 2 At the end of the IP address, add two colons and then enter the port number (in this example, the required port number is 115900), i.e. <http://192.168.0.3::115900>
- 3 Continue with the standard [VNC viewer instructions](#).

Viewer encryption settings

The web browser viewers and VNC viewers (of level 4.0b5S or higher) offer four encryption options. The resulting actions of certain options depend upon how the AdderLink IP to which you are connecting is configured:

- **Always on** - This setting will ensure that the link is encrypted, regardless of the AdderLink IP encryption setting.
- **Let server choose** - This setting will follow the configuration of the AdderLink IP. If the AdderLink IP has a preference to encrypt the link, then it will be so, otherwise the link will not be encrypted.
- **Prefer off** - This setting will configure an un-encrypted link if the AdderLink IP will allow it, otherwise it will be encrypted.
- **Prefer on** - If the AdderLink IP allows it, this setting will configure an encrypted link, otherwise it will be un-encrypted.

Whenever encryption does take place, the viewer will first need to create the necessary secure key before the connection process can continue.

Supported web browsers

The following web browsers have been tested and found to work correctly with AdderLink IP.

Windows

- Internet Explorer 5.50 and above,
with Microsoft [Java] Virtual Machine (release 5.50).
with Java Runtime Environment 1.3 or above.

Linux

- Netscape 4.61 and above,
with Java Runtime Environment 1.1 or above.
- Opera,
with Java Runtime Environment 1.1 or above.



INSTALLATION

CONFIGURATION

OPERATION

FURTHER
INFORMATION

INDEX

Further information



This chapter contains a variety of information, including the following:

- Getting assistance - see below
- Troubleshooting - see right
- Appendices
 - Appendix 1 - [Local configuration menus](#)
 - Appendix 2 - [VNC viewer connection options](#)
 - Appendix 3 - [VNC viewer window options](#)
 - Appendix 4 - [Browser viewer options](#)
 - Appendix 5 - [Remote configuration menus](#)
 - Appendix 6 - [Addresses, masks and ports](#)
 - Appendix 7 - [Cable specifications](#)
 - Appendix 8 - [Hotkey sequence codes](#)
- [Safety information](#)
- [Warranty](#)
- [End user licence agreement](#)
- [Radio frequency energy statements](#)

Getting assistance

If you are still experiencing problems after checking the list of solutions in the Troubleshooting section then we provide a number of other solutions:

- Adder Technology website – www.adder.com
Check the Support section of our website for the latest solutions and driver files.
- Email – support@adder.com
- Fax
 - in the UK: **01954 780081**
 - in the US: **+1 888 275 1117**
- Phone
 - in the UK: **01954 780044**
 - in the US: **+1 888 932 3337**

Troubleshooting

Remote network users are unable to contact the AdderLink IP

- Check that the correct address is being used by the remote users.
- Check the [network settings](#). Check that the users network address has not been excluded in the [IP access control section](#).
- If the AdderLink IP is situated behind a firewall, check that the relevant ports are being allowed [through the firewall](#) and are being correctly routed.
- Check the [front panel indicators](#), the LNK indicator should be on. If the network link is a 100Mbps connection, the 100 indicator should also be on.

The remote cursor is not correctly responding to my mouse movements

- [Recalibrate the mouse](#). When doing so, ensure that the host system does not have mouse cursor trails enabled and that the top left corner of the screen is clear of application windows.

When logging on using VNC viewer, I cannot enter a username

- Either, the VNC viewer is an old version ([download a new one](#)) or only the admin user has been configured on the AdderLink IP.

INSTALLATION

CONFIGURATION

OPERATION

FURTHER INFORMATION

INDEX

Appendix 1 - Local configuration menus

This section covers the control menus that are available when you are using the locally connected keyboard, video monitor and mouse.

To access the local configuration menus

- On the locally connected keyboard, simultaneously press **Ctrl** **Alt** **C**.

Note: If the standard hotkeys (CTRL + ALT) have been changed, then you need to use those keys together with C to access the menus.

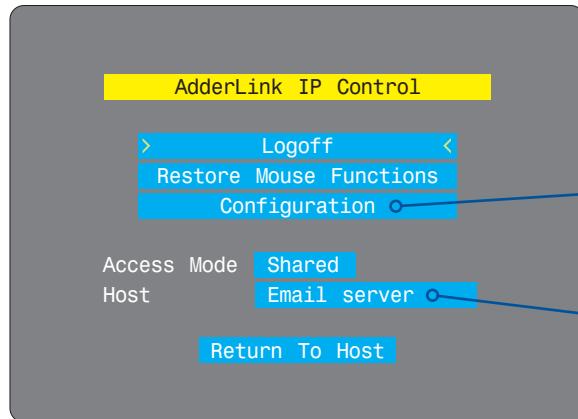

If you are not logged on as the 'admin' user then the Configuration menu will not be available.

Use the Host entry to switch to the required host computer (when a KVM switch is used).

Select the 'Configuration' option to display:

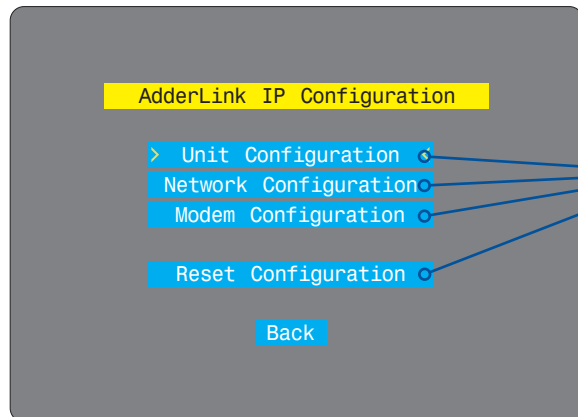

Select the required option:

- [Unit configuration](#)
- [Network configuration](#)
- [Modem configuration](#)
- [Reset configuration](#)

Unit configuration

This page provides access to a selection of both basic and fundamental settings for the AdderLink IP.

Hardware	Rev 1
Firmware	Version 1.4
Keybd Layout	UK
Admin Passwd	
Unit Name	
Hot Keys	Ctrl+Alt
Screensaver	10 mins
Time	21 : 27 : 31
Date	15 Apr 2004
Encryption	Prefer Off

Save Cancel

Keybd layout

Use the arrow buttons to match the keyboard layout expected by the host system.

Admin password

Enter the password that will be used to gain administrator access to the AdderLink IP. There can only be one admin user and only that user is given access to the configuration menus. The admin password background will be red until a reasonably secure password has been entered, although this is only advisory as any password or no password may be entered.

Unit name

The name entered here will be displayed on the local menus and the remote VNC/browser windows.

Hot keys

Use the left and right arrow keys to select an appropriate hot key sequence for the locally connected keyboard. This sequence is used in combination with other keypresses to access the on-screen menus and to change between hosts. The options are: Ctrl+Alt (default), Ctrl+Shift, Alt+Shift, Alt Gr, Left + Right Alt, Left Ctrl + Alt or Right Ctrl + Alt.

To get here

- 1 Use the local keyboard and log on as the 'admin' user.
- 2 Press (hotkeys may be different).
- 3 Select 'Configuration'.
- 4 Select 'Unit configuration'.

Screensaver

Use the left and right arrow keys to select an appropriate period of inactivity on the local keyboard or mouse before a screensaver is displayed and the user is logged out. This setting applies to local users only and once the screensaver is displayed, for security purposes the user is required to log in again. The timeout period can be selected between 5 minutes and 1 day (24 hours), it cannot be disabled. *Note: The [Idle timeout](#) option serves a similar purpose for remote connections.*

Time and date

Use the left and right arrow keys to select the correct time and date. The time entry uses the 24 hour clock notation. The internal real time clock will continue to run for roughly one week without power to the AdderLink IP, after that it will be lost and require resetting. Use the up and down arrow keys to move between each of the sections within the time and date entries.

Encryption

Three options are available: Always on, prefer off, prefer on. The one to choose depends on the specific details of your installation - see [Encryption settings](#) for details. The use of encryption imposes a slight performance overhead of roughly 10% but is highly secure against third party intrusion.



Network configuration

This page allows you to configure the various aspects of the IP port and its relationship with the local network.

MAC Address	00:0F:58:00:00:04
Use DHCP	No
IP Address	192.168.42.154
Net Mask	255.255.255.0
Gateway	
VNC Port	5900
HTTP Port	80
>Clear IP Access Control<	
Save	Cancel

MAC address

Media Access Control address – this is the unique and unchangeable code that was hard coded within your AdderLink IP unit when it was built. It consists of six 2-digit hexadecimal (base 16) numbers separated by colons. A section of the MAC address identifies Adder Technology as the manufacturer, while the remainder is effectively the unique electronic serial number of your particular unit.

Use DHCP

DHCP is an acronym for 'Dynamic Host Configuration Protocol'. Its function is particularly useful when connecting to medium size or larger networks, such as the Internet. When this option is selected, your AdderLink IP will attempt to locate a DHCP server on the network. If such a server is located, it will supply three things to the AdderLink IP: an IP address, an IP network mask (also known as a Subnet mask) and a Gateway address. These are not usually granted permanently, but on a 'lease' basis for a fixed amount of time or for as long as the AdderLink IP remains connected and switched on. [Discover allocations.](#)

IP address

This is the identity of the AdderLink IP within a network. The IP address can be thought of as the telephone number of the AdderLink IP. Unlike the MAC address, the IP address can be altered to suit the network to which it is connected. It can either be entered manually or configured automatically using the DHCP option. When the DHCP option is enabled, this entry is greyed out.

Net mask

Also often called the 'subnet-mask', this value is used alongside the IP address to help define a smaller collection (or subnet) of devices on a network. In this way a distinction is made between locally connected devices and ones that are reachable elsewhere, such as on the wider Internet. This process helps to reduce overall traffic on the network and hence speed up connections in general.

To get here

- 1 Use the local keyboard and log on as the 'admin' user.
- 2 Press **Ctrl** **Alt** **C** (hotkeys may be different).
- 3 Select 'Configuration'.
- 4 Select 'Network configuration'.

Gateway

This is the address of the device that links the local network (to which the AdderLink IP is connected) to another network such as the Internet. Usually this is a network switch or router and it will be used whenever a device to be contacted lies outside the local network.

VNC port

This is the logical link through which communications with a remote VNC viewer will be channelled (see [What is a port?](#)). The default setting is 5900 which is a widely recognised port number for use by VNC software. However, in certain circumstances it may be advantageous to alter this number - see [Security issues with ports](#) for more details.

Note: The VNC port and HTTP port can be set to the same port number in order to simplify router and firewall configuration. If this is done then the AdderLink IP will "listen" for both types of traffic on the single port.

HTTP port

This is the logical link through which communications with a remote web browser will be channelled. The default setting of 80 is an established standard for web (HTTP – HyperText Transfer Protocol) traffic though this can be changed to suit your local network requirements.

Clear IP access control

This option removes all entries from the IP access control feature within the AdderLink IP. The IP access control feature (configurable by a remote admin user) allows certain network address ranges to be denied access to the AdderLink IP. If set incorrectly, it is possible to exclude all network users and so this option provides an emergency recovery point.



Modem configuration

This page allows you to configure the COM1 serial port located at the rear of the AdderLink IP.

AdderLink IP Modem Config

Server IP 192.168.3.1
Client IP 192.168.3.2
Baud Rate 115200
Init String ATZHS0=1

Initialize Port
Restore Defaults

> Save < Cancel

Server IP / Client IP

When a user dials into the AdderLink IP via a modem or ISDN adapter, the AdderLink IP sets up a temporary two-device network using PPP (Point to Point Protocol). For this purpose, both devices must have 'dummy' IP addresses so that they can communicate correctly. These two addresses can be almost anything expressed in the quad octet format (i.e. 192.168.3.1.). However, it is advisable not to make them the same as the real IP addresses used by either the remote system or the AdderLink IP.

Baud rate

This option configures the speed of the serial connection between the AdderLink IP and a connected modem or ISDN terminal adapter. The default setting is 115200. The other communication settings are fixed as: No parity, 8 bit word, 1 stop bit.

To get here

- 1 Use the local keyboard and log on as the 'admin' user.
- 2 Press **Ctrl** **Alt** **C** (hotkeys may be different).
- 3 Select 'Configuration'.
- 4 Select 'Modem configuration'.

Init string

The codes entered here are used to prepare the connected modem or ISDN terminal adapter for use with the AdderLink IP. The default code is a Hayes-compatible string to configure auto answer mode and would be understood by the vast majority of modem/ISDN devices. The code is sent when the AdderLink IP is first switched on or whenever the Initialize button is clicked.

Initialize port

When selected, this option sends the characters entered in the 'Init string' field to the connected modem or ISDN terminal adapter.

Restore Defaults

When selected, this option resets the 'Baud rate' and 'Init string' values to their original default settings.



Reset configuration

This option allows you to completely reset the AdderLink IP.

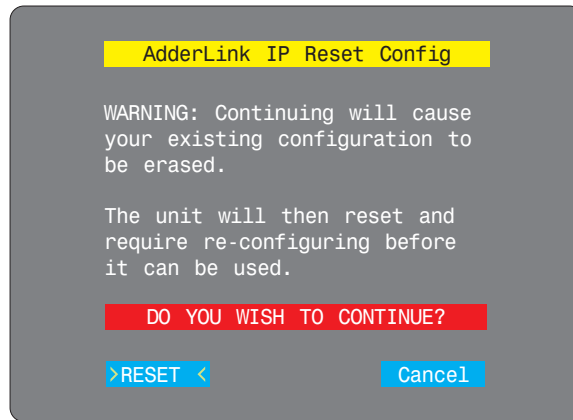



WARNING: This process will remove all settings and return the unit to use its original state. A complete reconfiguration will be required before it can be used.

To reset the AdderLink IP configuration

- 1 With the RESET option highlighted, press .
- 2 The first screen of the initial configuration process will be displayed. See [Initial configuration](#) for details.

To get here

- 1 Use the local keyboard and log on as the 'admin' user.
- 2 Press    (hotkeys may be different).
- 3 Select 'Configuration'.
- 4 Select 'Reset configuration'.

Clear IP access control

This option removes all entries from the IP access control feature within the AdderLink IP.

What is IP access control?

The IP access control feature (configurable by a remote admin user) allows certain network address ranges to be denied access to the AdderLink IP. If set incorrectly, it is possible to exclude all network users and so this option provides an emergency recovery point.

To clear IP access control

- 1 Use the local keyboard and log on as the 'admin' user.
- 2 Press **Ctrl** **Alt** **C** (hotkeys may be set differently).
- 3 Select 'Configuration'.
- 4 Select 'Network configuration'.
- 5 Highlight the 'Clear IP access control' option and press **↓**.

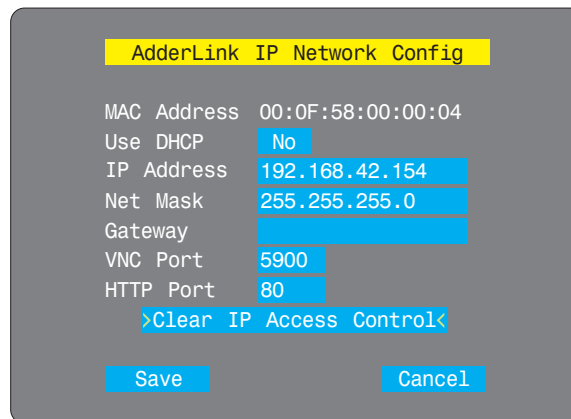

The screenshot shows a terminal window titled "AdderLink IP Network Config". The configuration parameters are as follows:

MAC Address	00:0F:58:00:00:04
Use DHCP	No
IP Address	192.168.42.154
Net Mask	255.255.255.0
Gateway	
VNC Port	5900
HTTP Port	80

The option ">Clear IP Access Control<" is highlighted in blue. At the bottom of the window, there are "Save" and "Cancel" buttons.

Appendix 2 - VNC viewer connection options

When you are connecting to the AdderLink IP using the VNC viewer, a number of options are available.

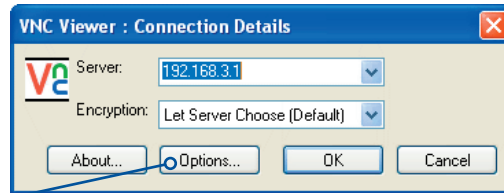

Click here to access the options

There are five tabbed pages of options:

Colour/Encoding

Auto select

When ticked, this option will examine the speed of your connection to the AdderLink IP and apply the most suitable encoding method. This option is suggested for the majority of installations.

Preferred encoding

There are three manually selectable encoding methods which are accessible when the Auto select option is unticked.

- **ZRLE** – This is a highly compressed method that is best suited to slow modem connections.
- **Hextile** – This method offers better performance than the ZRLE when used over a high speed network because there is no need for the AdderLink IP to spend time highly compressing the data.
- **Raw** – This is a primitive, uncompressed method that is mainly used for technical support issues. You are recommended not to use this method.

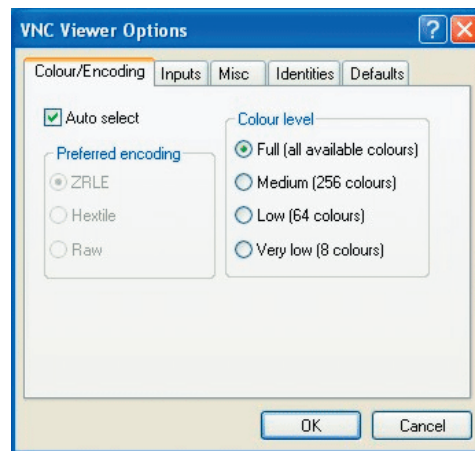

IMPORTANT: If you make any changes to the options given here and wish to retain them for successive connection sessions, you must save the changes. To do this, change to the 'Defaults' tab and click the 'Save as defaults' button.

Colour level

This section allows you to select the most appropriate colour level for the speed of the connection to the AdderLink IP. Where the connection speed is slow or inconsistent there will be a necessary compromise between screen response and colour depth.

- **Full** – This mode is suitable only for fast network connections and will pass on the maximum colour depth being used by the host system.
- **Medium (256 colours)** – This mode reduces the host system output to a 256 colour mode and is more suitable for ISDN and fast modem connections.
- **Low (64 colours)** – This mode is suitable for slower modem connections and reduces the host system output to 64 colours.
- **Very low (8 colours)** – This mode provides very rudimentary picture quality and hardly any speed advantage over the 64 colour setting. You are recommended not to use this mode.

Inputs

Send pointer events to server

When un-ticked, the VNC viewer will not send mouse movement or click data to the AdderLink IP or host system.

Send keyboard events to server

When un-ticked, the VNC viewer will not send keyboard information to the AdderLink IP or host system.

Send clipboard changes to server

This feature is restricted to software server versions of VNC and has no effect on AdderLink IP installations.

Accept clipboard changes from server

This feature is restricted to software server versions of VNC and has no effect on AdderLink IP installations, except for retrieving the activity log as described in the logging and status section.

Enable 3-button mouse emulation

This feature allows you to use a 2-button mouse to emulate the middle button of a 3-button mouse. When enabled, press the left and right mouse buttons simultaneously to create a middle button action. You are advised to generally use a 3-button mouse.

Rate-limit mouse move events

When ticked, this feature reduces the mouse movement information that is sent to the AdderLink IP and host system. This is useful for slow connections and you will notice that the remote cursor will catch up with the local cursor roughly once every second.

Menu key

This feature allows you to select which function key is used to display the VNC viewer options menu. The menu key is only way to exit from the full screen viewer mode.

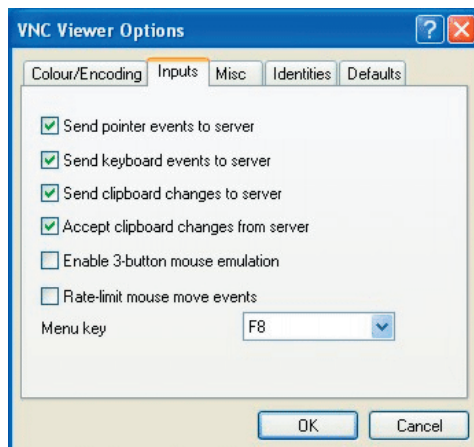

Misc

Shared connection (do not disconnect other viewers)

This option does not apply to AdderLink IP connections.

Full screen mode

When ticked, the VNC viewer will launch in full screen mode. Use the menu key (usually F8) to exit from full screen mode.

Render cursor locally

This option does not currently apply to AdderLink IP connections.

Allow dynamic desktop resizing

When ticked, the viewer window will be automatically resized whenever the host system's screen resolution is altered.

Only use protocol version 3.3

This option does not apply to AdderLink IP connections.

Beep when requested to by the server

When ticked, your local system will beep in response to any error beeps emitted by the AdderLink IP.

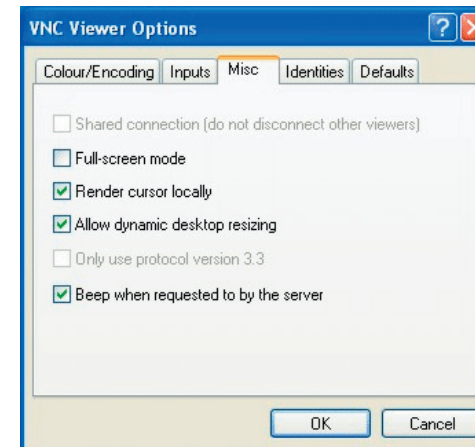

IMPORTANT: If you make any changes to the options given here and wish to retain them for successive connection sessions, you must save the changes. To do this, change to the 'Defaults' tab and click the 'Save as defaults' button.



Identities

This feature helps your VNC viewer to confirm that a revisited AdderLink IP is genuine and not another device masquerading as an AdderLink IP. The list given will retain the identities of all visited AdderLink IP units (that have full security enabled).

When you first make a secure connection to the AdderLink IP, the security information for that AdderLink IP unit is cached within this Identity tab (i.e. the AdderLink IP's "identity" is known). The next time that you connect to the AdderLink IP, its identity is checked against the stored version. If a mismatch is found between the current and the stored identities then a warning will be issued to you.

If an existing AdderLink IP is fully reconfigured then it will need to be issued with a new identity. In this case the previous identity, listed in this tab, should be removed so that a new identity can be created on the next connection.

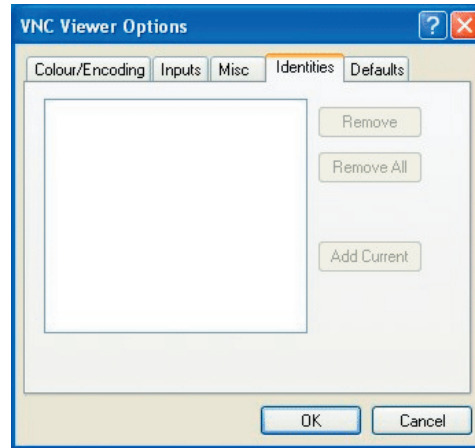

Defaults

Reload defaults

When clicked, all connection options are returned to the default settings that are currently saved.

Save as defaults

When clicked, saves the current connection options as the default set that will be used in all subsequent VNC connections.

Save configuration file as...

Allows you to save the current settings so that they can be copied from one viewer to another.

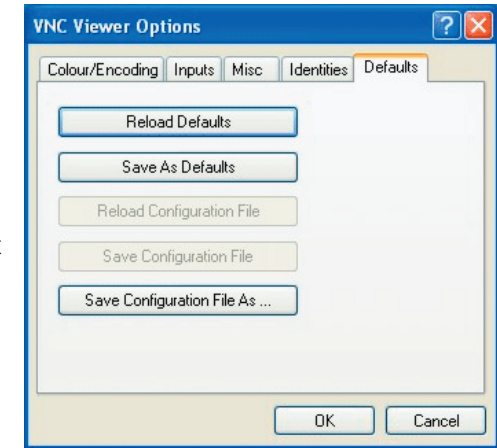

Appendix 3 - VNC viewer window options

Click the VNC icon in the top left corner of the viewer window (or press F8) to display the window options:

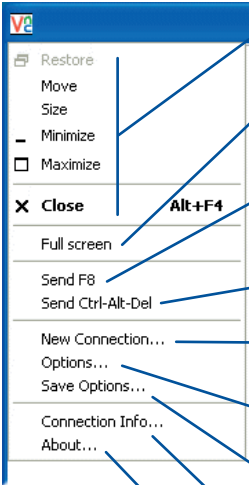
- 
- **Standard window control items**
 - **Full screen**
Expands the VNC viewer window to fill the whole screen with no visible window edges or toolbar. Press F8 to re-display this menu.
 - **Send F8**
Passes the F8 function key code to the AdderLink IP and host system. This is necessary because F8 is trapped by the VNC viewer for use as the trigger for this options menu.
 - **Send Ctrl-Alt-Del**
Passes a Ctrl-Alt-Del sequence to the host system.
 - **New connection...**
Displays the connection dialog so that you can log on to a different AdderLink IP or VNC server location.
 - **Options...**
Displays the full range of connection options - see [Appendix 2](#) for more details.
 - **Save options...**
Allows you to save the current VNC connection options for use during the next session.
 - **Connection info...**
Displays various connection and display details.
 - **About...**
Displays information about your VNC viewer.

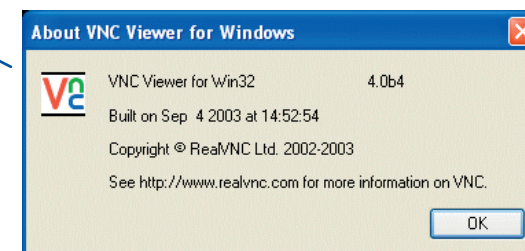
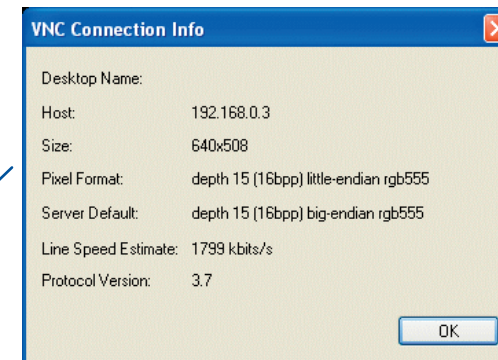
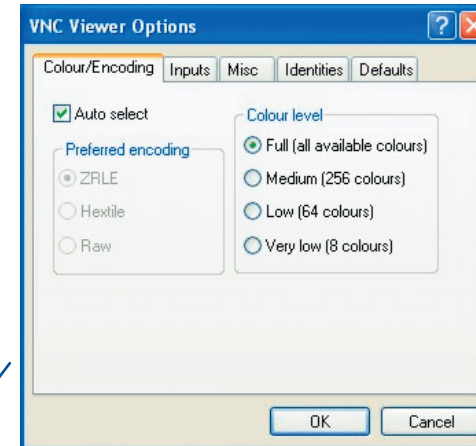
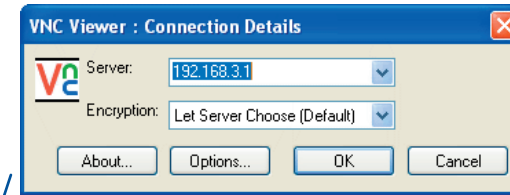

Appendix 4 - Browser viewer options

When you are connecting to the AdderLink IP using a Web browser, a number of options are available.

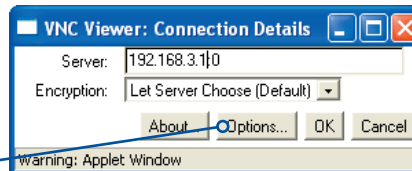

Click here to access the options

There is a single page of options:

Encoding and colour level

Auto select

When ticked, this option will examine the speed of your connection to the AdderLink IP and apply the most suitable encoding method. This option is suggested for the majority of installations.

Preferred encoding

There are three manually selectable encoding methods which are accessible when the Auto select option is unticked.

- **ZRLE** – This is a highly compressed method that is best suited to slow modem connections.
- **Hextile** – This method offers better performance than the ZRLE when used over a high speed network because there is no need for the AdderLink IP to spend time highly compressing the data.
- **Raw** – This is a primitive, uncompressed method that is mainly used for technical support issues. You are recommended not to use this method.

Colour level

The colour level is fixed at Medium (256 colours) for almost all browsers.

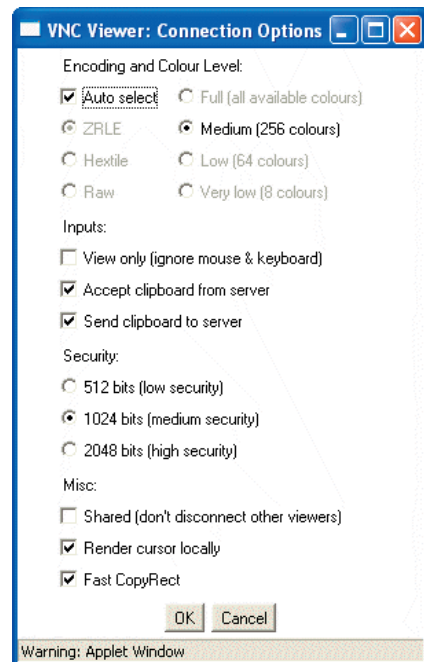

Inputs

View only (ignore mouse & keyboard)

When ticked, the viewer will not send keyboard or mouse information to the AdderLink IP or host system.

Accept clipboard from server

This feature is restricted to software server versions of VNC and has no effect on AdderLink IP installations.

Send clipboard to server

This feature is restricted to software server versions of VNC and has no effect on AdderLink IP installations.

Security

512 bits (low security)

Selects the lowest level of encoding for communications between the browser and the AdderLink IP.

1024 bits (medium security)

Selects the middle level of encoding for communications between the browser and the AdderLink IP.

2048 bits (high security)

Selects the highest level of encoding for communications between the browser and the AdderLink IP.

Misc

Shared (don't disconnect other viewers)

This feature is restricted to software server versions of VNC and has no effect on AdderLink IP installations.

Render cursor locally

This feature is restricted to software server versions of VNC and has no effect on AdderLink IP installations.

Fast CopyRect

This feature is restricted to software server versions of VNC and has no effect on AdderLink IP installations.



Appendix 5 - Remote configuration menus

This section covers the configuration menus that are available to remote admin users using either the VNC viewer or the browser methods of access.

To access the remote configuration menus

- Click the Configure button in the top right corner of the window when logged on as the admin user.

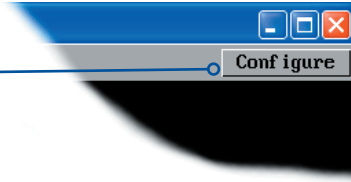

Main configuration menu

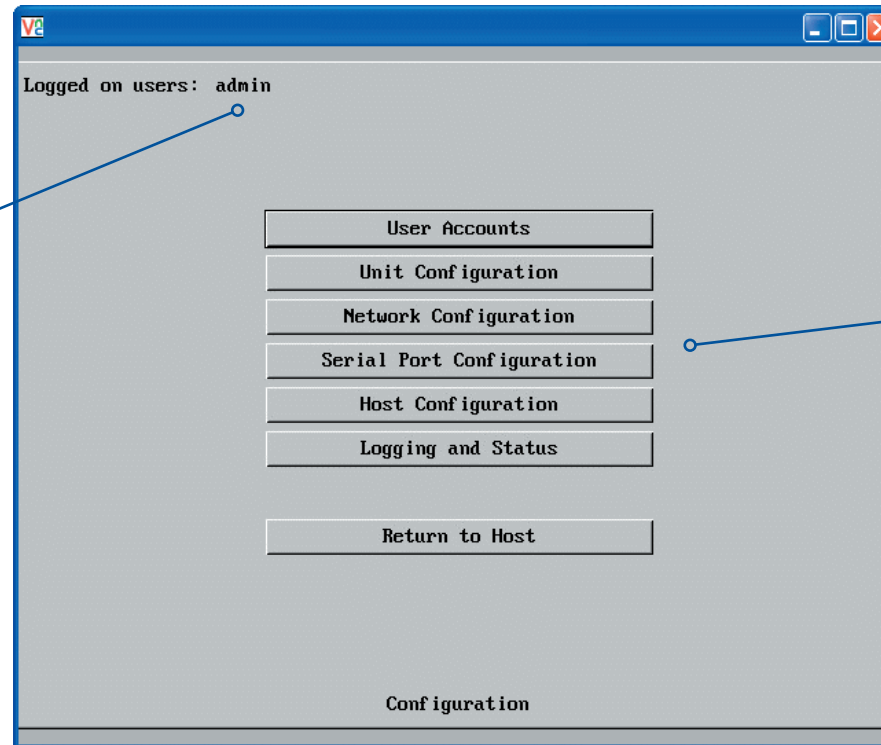

Logged on users

Indicates the current users irrespective of whether they are connected locally, by modem/ISDN or via a network.

Click the required option

- [User accounts](#)
- [Unit configuration](#)
- [Network configuration](#)
- [Serial port configuration](#)
- [Host configuration](#)
- [Logging and status](#)

User accounts

This section allows you to manage up to sixteen separate accounts.

The first of the sixteen accounts is the admin account and is the only account with access rights to the configuration menus. The user name and access rights are fixed for the admin account, the only change possible for this account is the password.

There are fifteen user account positions.

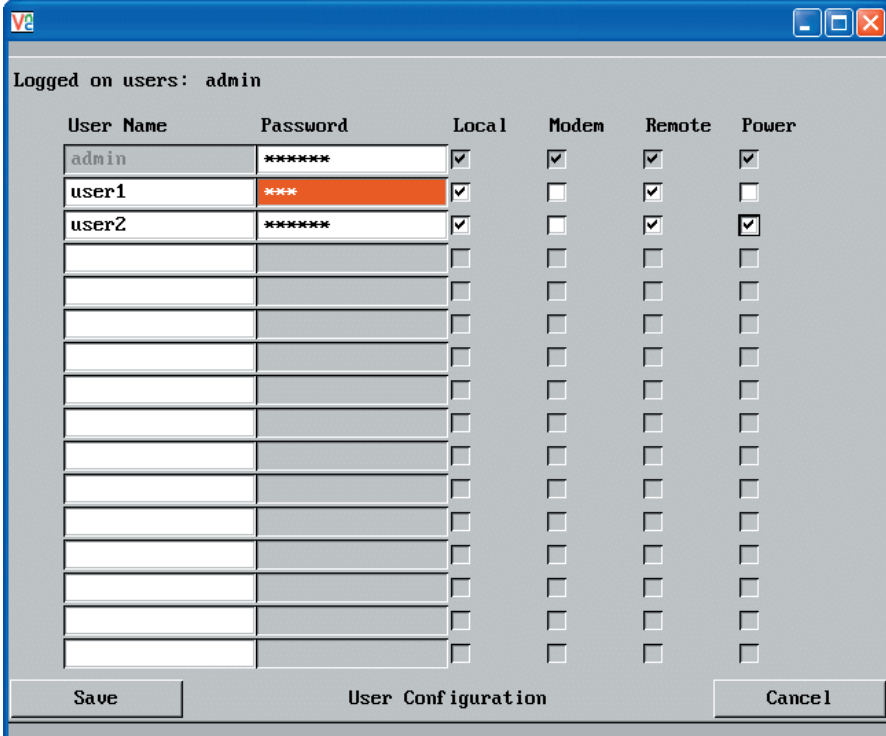

Logged on users: admin

User Name	Password	Local	Modem	Remote	Power
admin	*****	<input checked="" type="checkbox"/>	<input checked="" type="checkbox"/>	<input checked="" type="checkbox"/>	<input checked="" type="checkbox"/>
user1	***	<input checked="" type="checkbox"/>	<input type="checkbox"/>	<input checked="" type="checkbox"/>	<input type="checkbox"/>
user2	*****	<input checked="" type="checkbox"/>	<input type="checkbox"/>	<input checked="" type="checkbox"/>	<input checked="" type="checkbox"/>
		<input type="checkbox"/>	<input type="checkbox"/>	<input type="checkbox"/>	<input type="checkbox"/>
		<input type="checkbox"/>	<input type="checkbox"/>	<input type="checkbox"/>	<input type="checkbox"/>
		<input type="checkbox"/>	<input type="checkbox"/>	<input type="checkbox"/>	<input type="checkbox"/>
		<input type="checkbox"/>	<input type="checkbox"/>	<input type="checkbox"/>	<input type="checkbox"/>
		<input type="checkbox"/>	<input type="checkbox"/>	<input type="checkbox"/>	<input type="checkbox"/>
		<input type="checkbox"/>	<input type="checkbox"/>	<input type="checkbox"/>	<input type="checkbox"/>
		<input type="checkbox"/>	<input type="checkbox"/>	<input type="checkbox"/>	<input type="checkbox"/>
		<input type="checkbox"/>	<input type="checkbox"/>	<input type="checkbox"/>	<input type="checkbox"/>
		<input type="checkbox"/>	<input type="checkbox"/>	<input type="checkbox"/>	<input type="checkbox"/>
		<input type="checkbox"/>	<input type="checkbox"/>	<input type="checkbox"/>	<input type="checkbox"/>
		<input type="checkbox"/>	<input type="checkbox"/>	<input type="checkbox"/>	<input type="checkbox"/>
		<input type="checkbox"/>	<input type="checkbox"/>	<input type="checkbox"/>	<input type="checkbox"/>

Save User Configuration Cancel

To create a new account

- 1 Enter the required User Name to activate that position (the Password and access tick box positions will become editable).
- 2 Optionally enter a password for the user account.
- 3 Tick/untick the Local, Modem, Remote and Power options that are appropriate to the user.
- 4 Click the Save button to register your changes.

To get here

- 1 Using VNC viewer or a browser, log on as the 'admin' user.
- 2 Click the 'Configure' button in the top right corner.
- 3 Click the 'User accounts' option.

User Name

All user names must consist of lower case characters or numbers only. No symbols or upper case characters are permissible. The user name can be between 1 and 16 characters in length.

Password

Passwords are case sensitive and can include certain keyboard symbols. The password can be between 1 and 16 characters in length. It is important to note, however, that the password background remains shaded in amber while the AdderLink IP considers your entered password to be too easy to guess. A suitable password is best constructed using a mixture of more than 6 letters, numbers and punctuation characters.

Local

When ticked, the selected user can gain access using the local KVM console directly connected to the AdderLink IP.

Modem

When ticked, the selected user can gain access via a modem or ISDN link (requires external modem/ISDN equipment to be connected to the AdderLink).

Remote

When ticked, the selected user can gain access via an IP network link, such as a local intranet or the wider Internet (depending on how the AdderLink IP is connected).

Power

When ticked, the selected user will be permitted to control the power input to host systems (requires optional power control switch unit(s) to be fitted).



INSTALLATION

CONFIGURATION

OPERATION

FURTHER INFORMATION

INDEX

Unit configuration

This page provides access to a selection of both basic and fundamental settings for the AdderLink IP. Many of the settings displayed here are also accessible through the on-screen menu on the locally attached keyboard, mouse and monitor.

Logged on users: admin

Hardware Version: Rev 1

Firmware Version: Version 1.4

Host Keyboard Layout: UK

Admin Password: *****

Unit Name:

Local Hot Key Sequence: Ctrl+Alt

Screensaver Timeout: 10 mins

Time And Date: 16:11, 10 May 2004

Encryption: Prefer Off

Advanced Unit Configuration

Save Unit Configuration Cancel

Hardware Version

Indicates the version of the electronic circuitry within the AdderLink IP unit.

Firmware Version

Indicates the version of the hardwired software within the AdderLink IP's flash memory. This may be updated using the [flash upgrade procedure](#).

Host Keyboard Layout

Use the arrow buttons to match the keyboard layout expected by the host system.

Admin password

Enter the password that will be used to gain administrator access to the AdderLink IP. There can only be one admin user and only that user is given access to the configuration menus.

To get here

- 1 Using VNC viewer or a browser, log on as the 'admin' user.
- 2 Click the 'Configure' button in the top right corner.
- 3 Click the 'Unit configuration' option.

Unit name

The name entered here will be displayed on the local menus and the remote VNC/browser windows.

Local hot key sequence

Use the arrow buttons to select an appropriate hot key sequence for the locally connected keyboard. This sequence is used in combination with other keypresses to access the on-screen menus and to change between hosts. The options are: Ctrl+Alt (default), Ctrl+Shift, Alt+Shift, Alt Gr, Left + Right Alt, Left Ctrl + Alt or Right Ctrl + Alt.

Screensaver timeout

Use the arrow keys to select an appropriate period of inactivity before a screensaver is displayed and the user is logged out. This setting applies to local users only and once the screensaver is displayed, for security purposes the user is required to log in again. The timeout period can be selected between 5 minutes and 1 day (24 hours), it cannot be disabled.

Time and date

Use the arrow keys to select the correct time and date. The time entry uses the 24 hour clock notation. The internal real time clock will continue to run for roughly one week without power to the AdderLink IP, after that it will be lost and require resetting.

Encryption

Three options are available: Always on, prefer off, prefer on. The one to choose depends on the specific details of your installation - see [Encryption settings](#) for details. The use of encryption imposes a slight performance overhead of roughly 10% but is highly secure against third party intrusion.



Advanced unit configuration

Click this button to display several advanced options that do not normally require alteration.

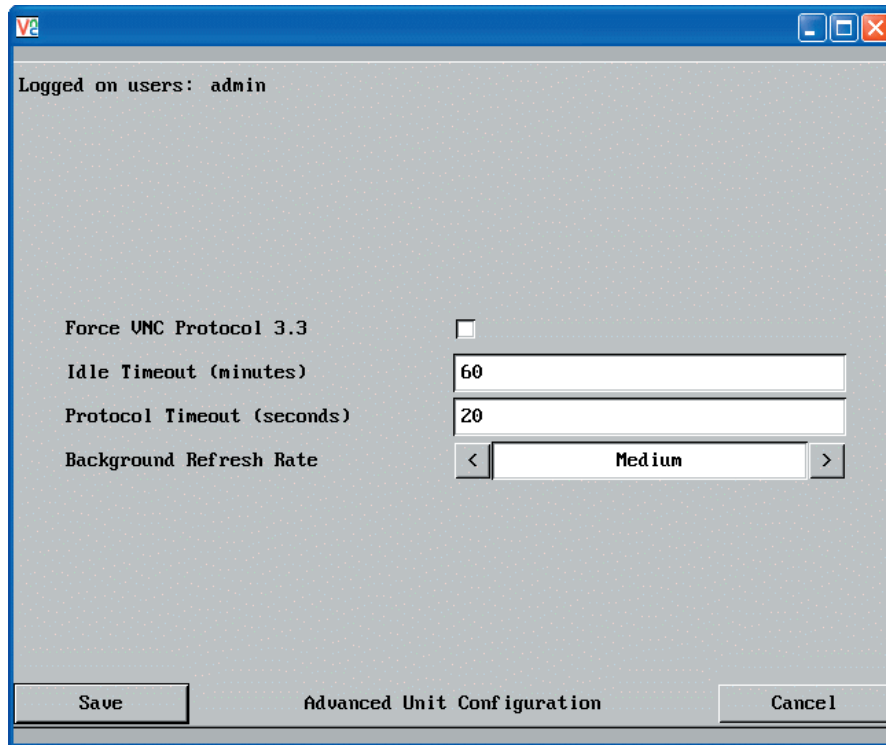

To get here

- 1 Using VNC viewer or a browser, log on as the 'admin' user.
- 2 Click the 'Configure' button in the top right corner.
- 3 Click the 'Unit configuration' option.
- 4 Click the 'Advanced unit configuration' option.

Force VNC protocol 3.3

IMPORTANT: The use of this option is not recommended. Protocol 3.3 is a legacy version that does not offer any encryption.

Idle timeout

Determines the period of inactivity on a remote connection before the user is logged out. The idle timeout period can be set to any time span, expressed in minutes. *Note: The [Screensaver](#) option serves a similar purpose for local connections.*

Protocol timeout

Sets the time period by which responses should have been received to outgoing data packets. If the stated period is exceeded, then a connection is considered lost and terminated.

Background refresh rate

Use the arrow keys to alter the refresh rate for screen images via remote links. This allows you to tailor the screen refresh to suit the network or modem connection speeds. The options are: Slow, Medium, Fast or Disabled. When the disabled option is selected, the remote users will need to manually refresh the screen.

Note: When a low connections speed is detected, the background refresh is automatically disabled, regardless of the settings of this option.

Network configuration

This page allows you to configure the various aspects of the IP port and its relationship with the local network.

Logged on users: admin

MAC address: 00:0F:58:00:00:03

Use DHCP

IP Address 192.168.0.3

IP Network Mask 255.255.255.0

IP Gateway 192.168.0.1

UNC Port 5900

HTTP Port 80

IP Access Control

Add Remove Up Down Edit

+0.0.0.0/0.0.0.0

Save Network Configuration Cancel

MAC address

Media Access Control address – this is the unique and unchangeable code that was hard coded within your AdderLink IP unit when it was built. It consists of six 2-digit hexadecimal (base 16) numbers separated by colons. A section of the MAC address identifies Adder Technology as the manufacturer, while the remainder is effectively the unique electronic serial number of your particular unit.

Use DHCP

DHCP is an acronym for 'Dynamic Host Configuration Protocol'. Its function is particularly useful when connecting to medium size or larger networks, such as the Internet. When this option is selected, your AdderLink IP will attempt to locate a DHCP server on the network. If such a server is located, it will supply three things to the AdderLink IP: an IP address, an IP network mask (also known as a Subnet mask) and a Gateway address. These are not usually granted permanently, but on a 'lease' basis for a fixed amount of time or for as long as the AdderLink IP remains connected and switched on. [Discover allocations.](#)

To get here

- 1 Using VNC viewer or a browser, log on as the 'admin' user.
- 2 Click the 'Configure' button in the top right corner.
- 3 Click the 'Network configuration' option.

IP address

This is the identity of the AdderLink IP within a network. The [IP address](#) can be thought of as the telephone number of the AdderLink IP. Unlike the MAC address, the IP address can be altered to suit the network to which it is connected. It can either be entered manually or configured automatically using the DHCP option. When the DHCP option is enabled, this entry is greyed out.

IP network mask

Also often called the [subnet-mask](#), this value is used alongside the IP address to help define a smaller collection (or subnet) of devices on a network. In this way a distinction is made between locally connected devices and ones that are reachable elsewhere, such as on the wider Internet. This process helps to reduce overall traffic on the network and hence speed up connections in general.

IP gateway

This is the address of the device that links the local network (to which the AdderLink IP is connected) to another network such as the wider Internet. Usually the actual gateway is a network switch or router and it will be used whenever a required address lies outside the current network.

VNC port

This is the logical link through which communications with a remote VNC viewer will be channelled (see [What is a port?](#)). The default setting is 5900 which is a widely recognised port number for use by VNC software. However, in certain circumstances it may be advantageous to alter this number - see 'Security issues with ports' for more details.

HTTP port

This is the logical link through which communications with a remote web browser will be channelled (see [What is a port?](#)). The default setting of 80 is an established standard for web (HTTP – HyperText Transfer Protocol) traffic though this can be changed to suit your local network requirements.

IP access control

This section allows you to optionally specify ranges of addresses which will or won't be granted access to the AdderLink IP. If this option is left unchanged, then the default entry of '+0.0.0.0/0.0.0.0' ensures that access from all IP addresses will be permitted. See [Setting IP access control](#) for details.



Setting IP access control

The golden rule with this feature is 'Include before you exclude' or to put it another way 'Arrange *allowed* addresses in the list *before* the *denied* addresses'.

This is because the positions of entries in the list are vitally important. Once a range of addresses is denied access, it is not possible to make exceptions for particular addresses within that range. For instance, if the range of addresses from A to F are denied access first, then the address C could not be granted access lower down the list. Address C needs to be placed in the list before the denied range.

IMPORTANT: This feature should be configured with extreme caution as it is possible to deny access to everyone. If such an error occurs, see [Clear IP access control](#) for details about how to regain access.

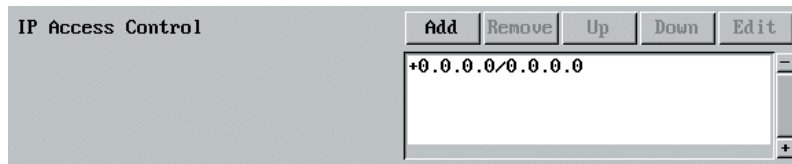

In the list, access control addresses prefixed by '+' are allow entries while those prefixed by '-' are deny entries.

To get here

- 1 Using VNC viewer or a browser, log on as the 'admin' user.
- 2 Click the 'Configure' button in the top right corner.
- 3 Click the 'Network configuration' option.

To define a new IP access control entry

- 1 Click the Add button to display a popup dialog:

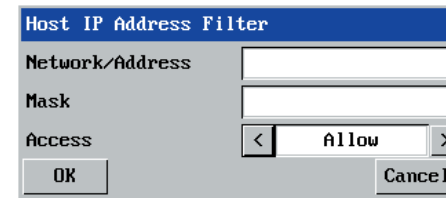

Network/Address

Enter the network address that is to be allowed or denied access. If a range of addresses is being specified then specify any one of the addresses within the range and use the Mask entry to indicate the size of the range.

Mask

Enter an IP network mask that indicates the range of addresses that are to be allowed or denied access. For instance, if only a single specified IP address were to be required, the mask entry would be 255.255.255.255 in order to specify a single location. See [Calculating the mask for IP access control](#) for details.

Access

Use the arrow buttons to select either 'Allow' or 'Deny' as appropriate.

- 2 Enter the base [network address](#), the [mask](#) and select the appropriate access setting.
- 3 Click the OK button.

To reorder access control entries

IMPORTANT: When reordering, ensure that any specific allowed addresses are listed higher in the list than any denied addresses. Take care not to invoke any deny access settings that would exclude valid users.

- 1 In the access control list, click on the entry to be moved.
- 2 Click the Up or Down buttons as appropriate.

To edit/remove access control entries

- 1 In the access control list, click on the appropriate entry.
- 2 Click either the Edit or Remove button as appropriate.

Serial port configuration

This page provides all access to settings concerned with the two serial ports (modem and power control) that are situated at the rear of the AdderLink IP.

The screenshot shows a window titled 'Serial Configuration' with a 'V2' icon in the top left corner. The window displays the following settings:

- Logged on users: admin
- Modem Port**
 - PPP Server IP Address: 192.168.3.1
 - PPP Client IP Address: 192.168.3.2
 - Baud Rate: 115200
 - Initialization Sequence: ATZHS0=1
 - Buttons: Initialize, Restore Defaults
- Power Control Port**
 - Baud Rate: 9600
- Buttons: Save, Cancel

To get here

- 1 Using VNC viewer or a browser, log on as the 'admin' user.
- 2 Click the 'Configure' button in the top right corner.
- 3 Click the 'Serial port configuration' option.

Modem port

PPP server IP address / PPP client IP address

When a user dials into the AdderLink IP via a modem or ISDN adapter, the AdderLink IP sets up a temporary two-device network using PPP (Point to Point Protocol). For this purpose, both devices must have 'dummy' IP addresses so that they can communicate correctly. These two addresses can be almost anything expressed in the quad octet format (i.e. 192.168.3.1.). However, it is advisable not to make them the same as the real IP addresses used by either the remote system or the AdderLink IP.

Baud rate

This option configures the speed of the serial connection between the AdderLink IP and a connected modem or ISDN terminal adapter. The default setting is 115200. The other communication settings are fixed as: No parity, 8 bit word, 1 stop bit.

Initialization sequence

The codes entered here are used to prepare the connected modem or ISDN terminal adapter for use with the AdderLink IP. The default code is a Hayes-compatible string to configure auto answer mode and would be understood by the vast majority of modem/ISDN devices. The code is sent when the AdderLink IP is first switched on or whenever the Initialize button is clicked.

Initialise

When clicked, this option sends the characters entered in the Initialisation sequence field to the connected modem or ISDN terminal adapter.

Restore Defaults

When clicked, this option resets the Baud rate and Initialisation sequence values to their original default settings.

Power control port

Baud rate

This option configures the speed of the serial connection between the AdderLink IP and a connected power control unit. The default setting is 9600 as used by the majority of power units. The other communication settings are fixed as: No parity, 8 bit word, 1 stop bit.



INSTALLATION

CONFIGURATION

OPERATION

FURTHER INFORMATION

INDEX

Logging and status

This screen provides various details about the user activity on the AdderLink IP.

Date and time the event occurred

User name

Access method or remote IP address

Type of event

Date and time the event occurred	User name	Access method or remote IP address	Type of event
20 Apr 04 17:15:17	admin	192.168.0.2	Clear Log
20 Apr 04 17:26:29	admin	192.168.0.2	Logoff
20 Apr 04 17:27:10	admin	192.168.0.2	Logon
20 Apr 04 17:27:16	admin	192.168.0.2	Logoff
20 Apr 04 17:35:56	admin	local	Logoff
20 Apr 04 19:52:14	admin	192.168.0.2	Logon
20 Apr 04 19:53:54	admin	local	Logon
20 Apr 04 20:08:44	admin	local	Logoff
20 Apr 04 20:38:33	admin	192.168.0.2	Logoff
21 Apr 04 08:43:02			Power On
21 Apr 04 08:43:13	admin	192.168.0.2	Logon
21 Apr 04 08:43:26	admin	local	Logon
21 Apr 04 08:53:26	admin	local	Logoff
21 Apr 04 09:54:58	admin	192.168.0.2	Logoff
21 Apr 04 09:55:19	admin	192.168.0.2	Logon
21 Apr 04 11:36:20	admin	192.168.0.2	Logoff
21 Apr 04 12:01:41	admin	192.168.0.2	Logon
21 Apr 04 15:26:19	admin	local	Logon
21 Apr 04 17:07:33	admin	local	Logoff
21 Apr 04 17:15:17	admin	192.168.0.2	Logoff
22 Apr 04 09:01:25			Power On
22 Apr 04 09:29:09	admin	192.168.0.2	Logon
22 Apr 04 09:50:43	admin	local	Logon
22 Apr 04 09:51:36	admin	local	Logoff

Click to clear all log entries

Click to refresh the list

Click to return to the main menu

To copy and paste the log

You can copy the information listed within the log and paste it into another application.

- 1 While viewing the log screen, press Ctrl and C, to copy the data into the clipboard.
- 2 In a text application (i.e. Word, WordPad, Notepad) press Ctrl and V, or right mouse click and 'Paste'.

To get here

- 1 Using VNC viewer or a browser, log on as the 'admin' user.
- 2 Click the 'Configure' button in the top right corner.
- 3 Click the 'Logging and status' option.

Appendix 6 – Addresses, masks and ports

IP address, network masks and ports are all closely linked in the quest for one device to find another across disparate network links.

IP addresses

As a rough analogy, consider how you use the telephone system. The phone number for Adder Technology in the UK is **0044 (0)1954 780044**. This number consists of three distinct parts:

- **0044** connects from another country to the UK
- **(0)1954** selects the main telephone exchange in the Bar Hill area of Cambridgeshire, and
- **780044** is the unique code for Adder Technology within Bar Hill.

The important parts of the whole number depend on where you are. If you were based in the same local area as Adder Technology, there would be no point in dialling out of the UK, or even out of the area. The only part of the whole number that you are interested in is the final part: 780044.

In a similar way to the various parts of the telephone number, the four sections (or *Octets*) of every IP address have different meanings or “weights”. Consider the following typical IP address:

192.168.142.154

192 is the most global part of the number (akin to the *0044* of the phone number) and **154** is the most local (similar to the *780044* unique local code of the phone number).

When two network devices communicate with each other, they always “dial the whole number” regardless of their respective locations in a network. However, they still need to know whether the other device is local to them or not, and this is where the net mask comes into play.

Net masks

The net mask (or sub-net mask) informs a device as to its own position within a network. From this it can determine whether any other device is within the same local network or is situated further afield.

Taking the telephone number analogy given in the IP address section, in order to use the telephone system efficiently, it is vital for you to know your location relative to the person you are calling. In this way you avoid dialling unnecessary numbers.

When one network device needs to talk to another, the first thing that it will do is a quick calculation using its own IP address, the other device’s IP address and its own net mask. Suppose a device with address **192.168.142.154** and net mask **255.255.255.0** needed to communicate with a device at address **192.168.142.22**. The sending device would perform several calculations:

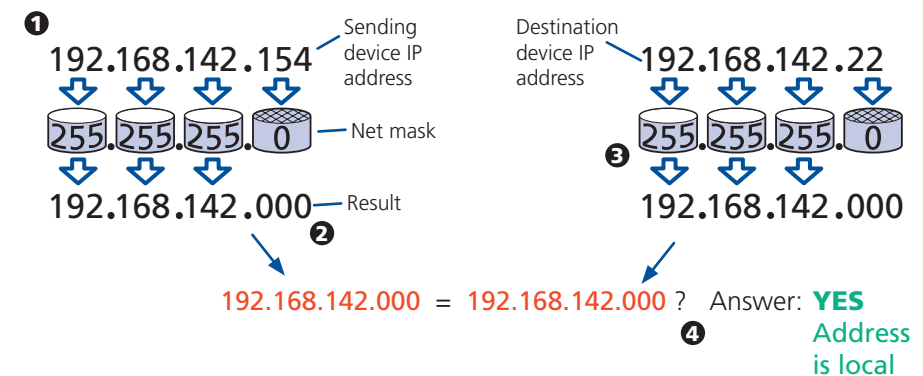

- 1 The net mask is used to determine the local and global parts of the sender’s IP address. Where there is 255 in the mask, the corresponding address slips through, where there is a 0, it is blocked.
- 2 Where the net mask was 0, the corresponding part of the result is also zero - this section is now known to be the local part of the IP address.
- 3 The same process is carried out for the destination address, again using the sender’s net mask. Now the local parts of both addresses have been equalised to zero, because their values are not important in determining whether they are both in the same local network.
- 4 The results of the two net mask operations are now compared, if they match, the destination is local. If not, then the sender will still use the same full destination IP address but will also flag the message to go via the local network gateway and out into the wider world.

The reason for doing this? It makes the network, as a whole, much more efficient. If every message for every recipient was shoved straight out onto the Internet, the whole thing would grind to a halt within seconds. Net masks keep local traffic just that - local.

[Want to know more?](#)



Net masks - the binary explanation

To really understand the operation of a net mask it is necessary to delve deeper into the life blood of computers – *binary*; this is native digital, where everything is either a 1 (one) or 0 (zero), on or off, yes or no.

The net mask operation described on the [previous page](#) is known as a ‘bit-wise AND function’. The example of 255.255.255.0 is handy because the last octet is completely zero and is “clean” for illustrative purposes. However, actual net mask calculations are carried out, not on whole decimal numbers, but bit by bit on binary numbers, hence the term ‘bit-wise’. In a real local network, a net mask might be 255.255.255.240. Such an example would no longer be quite so clear, until you look at the net mask in its binary form:

11111111.11111111.11111111.11110000

In this case, the four zeroes at the end of the net mask indicate that the local part of the address is formed by only the last four bits. If you use the diagram from the previous example and insert the new net mask, it will have the following effect on the final result:

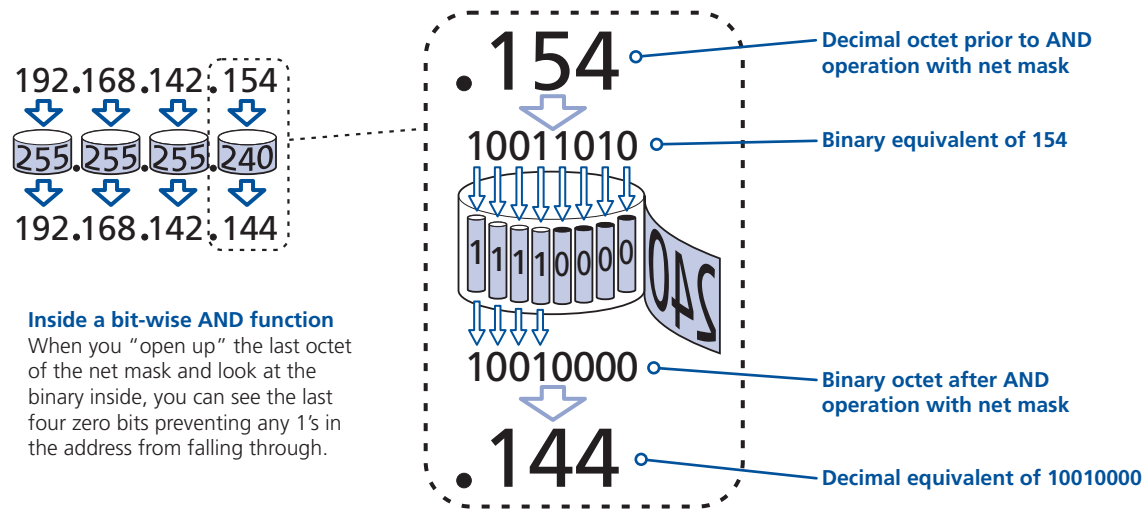

Thus, when 154 is *bit-wise ANDed* with 240, the result is 144. Likewise, any local address from 192.168.142.144 through to 192.168.142.159 would produce exactly the same result when combined with this net mask, hence they would all be local addresses. However, any difference in the upper three octets or the upper four bits of the last octet would slip through the mask and the address would be flagged as not being local.

Calculating the mask for IP access control

The IP access control function uses a standard IP address and a net mask notation to specify both single locations and ranges of addresses. In order to use this function correctly, you need to calculate the mask so that it accurately encompasses the required address(es).

Single locations

Some of the simplest addresses to allow or deny are single locations. In this case you enter the required IP address into the 'Network/Address' field and simply enter the 'Mask' as **255.255.255.255** (*255 used throughout the mask means that every bit of the address will be compared and so there can only be one unique address to match the one stated in the 'Network/Address' field*).

All locations

The other easy setting to make is ALL addresses, using the mask **0.0.0.0**. As standard, the IP access control section includes the entry: **+0.0.0.0/0.0.0.0**. The purpose of this entry is to *include* all IP addresses. It is possible to similarly *exclude* all addresses, however, take great care not to do this as you instantly render all network access void. There is a [recovery procedure](#) should this occur.

Address ranges

Although you can define ranges of addresses, due to the way that the mask operates, there are certain restrictions on the particular ranges that can be set. For any given address you can encompass neighbouring addresses in blocks of either 2, 4, 8, 16, 32, 64, 128, etc. and these must fall on particular boundaries. For instance, if you wanted to define the local address range:

192.168.142.67 to **192.168.142.93**

The closest single block to cover the range would be the 32 addresses from:

192.168.142.64 to **192.168.142.95**.

The mask needed to accomplish this would be: **255.255.255.224**

When you look at the mask in binary, the picture becomes a little clearer. The above mask has the form: **11111111.11111111.11111111.11100000**

Ignoring the initial three octets, the final six zeroes of the mask would ensure that the 32 addresses from .64 (01000000) to .95 (01011111) would all be treated in the same manner. See [Net masks - the binary explanation](#) for details.

When defining a mask, the important rule to remember is:

There must be no 'ones' to the right of a 'zero'.

For instance, (ignoring the first three octets) you could not use a mask that had **11100110** because this would affect intermittent addresses within a range in an impractical manner. The same rule applies across the octets. For example, if you have zeroes in the third octet, then all of the fourth octet must be zeroes.

The permissible mask values (for all octets) are as follows:

Mask octet	Binary	Number of addresses encompassed
255	11111111	1 address
254	11111110	2 addresses
252	11111100	4 addresses
248	11111000	8 addresses
240	11110000	16 addresses
224	11100000	32 addresses
192	11000000	64 addresses
128	10000000	128 addresses
0	00000000	256 addresses

If the access control range that you need to define is not possible using one address and one mask, then you could break it down into two or more entries. Each of these entries could then use smaller ranges (of differing sizes) that, when combined with the other entries, cover the range that you require.

For instance, to accurately encompass the range in the earlier example:

192.168.142.67 to **192.168.142.93**

You would need to define the following six address and mask combinations in the IP access control section:

Network/address entry	Mask entry	
192.168.142.67	255.255.255.255	defines 1 address (.67)
192.168.142.68	255.255.255.252	defines 4 addresses (.68 to .71)
192.168.142.72	255.255.255.248	defines 8 addresses (.72 to .79)
192.168.142.80	255.255.255.248	defines 8 addresses (.80 to .87)
192.168.142.88	255.255.255.252	defines 4 addresses (.88 to .92)
192.168.142.93	255.255.255.255	defines 1 address (.93)

Ports

If you accept the analogy of [IP addresses](#) being rather like telephone numbers, then think of ports as extension numbers. In a company of any size, you generally wouldn't expect the accounts department to share the same telephone with the technical department. Although their calls may all be related to the same company, they concern very different aspects of that company.

It is the same with IP network connections. Although you have only one network link into your computer and only one IP address (phone number), you are probably performing many different tasks through that one link, often at the same time. Thus, when you browse the web your outgoing requests and the incoming information are all channelled through port 80. When you send an email, it travels through port 25 and when you transfer files you are, without knowing it, using port 20.

At the "border crossing" between the wider Internet and every local network attached to it, there is a router that is usually combined with a firewall. One of its main tasks is to direct incoming traffic to the correct place within its local network. A key piece of information to help it do this is the port number:

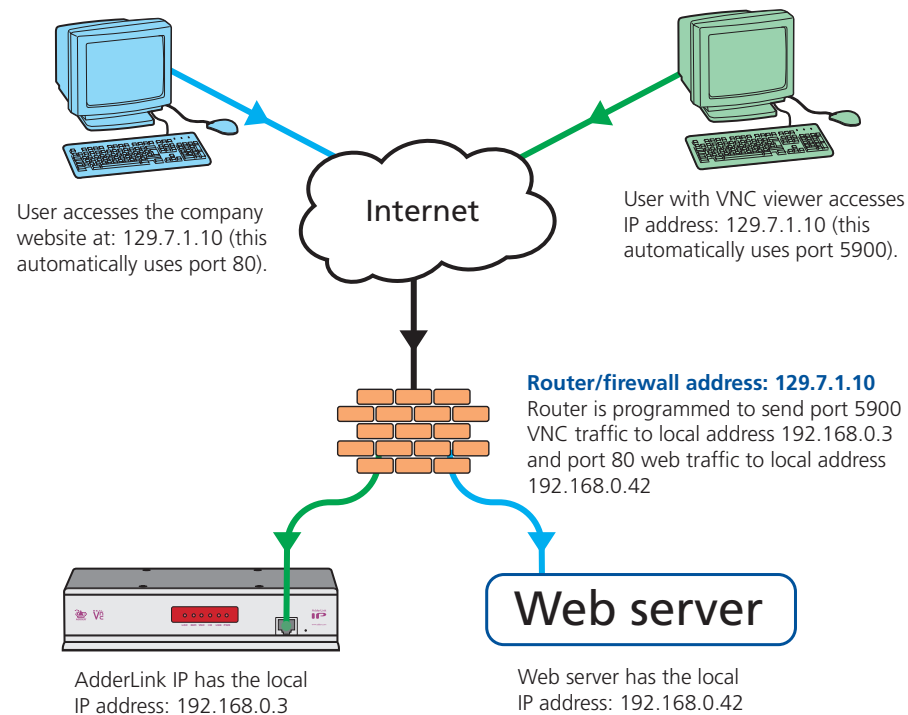

Security issues with ports

The settings of port numbers become important when the AdderLink IP is situated behind a network firewall. In order for a remote VNC viewer or web browser to make contact with your AdderLink IP, it is necessary for the firewall to allow communication through a particular numbered port to occur.

One specific function of firewalls is to restrict access to ports in order to prevent malicious attackers using them as a route into your network. Every new port that is opened offers a new possibility for hackers and so the number of accessible ports is purposefully kept to a minimum. In such cases, it may be advantageous to change one or both AdderLink IP ports to use the same number. The other alternative is to place the AdderLink IP unit outside the firewall and take full advantage of its secure operation features – see [Networking issues](#) for details.

IMPORTANT: The correct configuration of routers and firewalls requires advanced networking skills and intimate knowledge of the particular network. Adder Technology cannot provide specific advice on how to configure your network devices and strongly recommend that such tasks are carried out by a qualified professional.



INSTALLATION

CONFIGURATION

OPERATION

FURTHER INFORMATION

INDEX

Appendix 7 – Cable and connector specifications

RS232 serial mouse to PS/2 converter cable

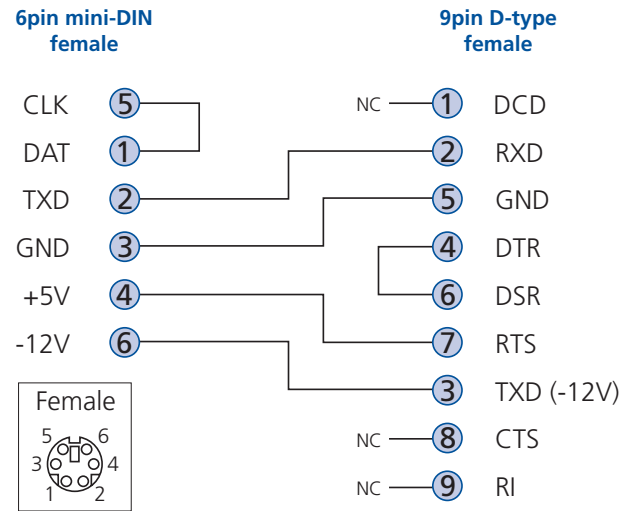

AdderLink IP to power switch cable

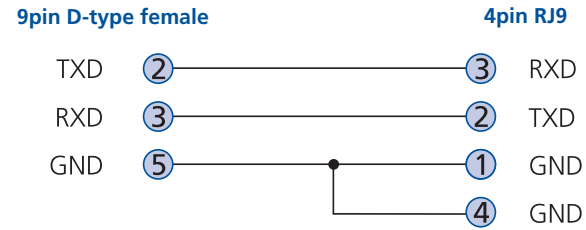

Power switch to power switch daisy chain cable

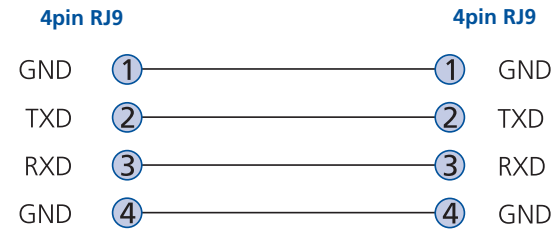

- INSTALLATION
- CONFIGURATION
- OPERATION
- FURTHER INFORMATION
- INDEX

Appendix 8 – Hotkey sequence codes

These codes are used when defining hotkey switching sequences for host computers and allow you to include almost any of the special keys on the keyboard.

Main control keys

Backspace | Tab | Return | Enter | Ctrl | Alt | Win | Shift | LShift | RShift
LCtrl | RCtrl | LAlt | AltGr | RAlt | LWin | RWin | Menu | Escape | Esc

Math operand keys

Add | Subtract | Multiply

Central control keys

Insert | Delete | Home | End | PageUp | PageDown
Up | Down | Left | Right | Print | ScrollLock | Pause

Keypad keys

KP_Insert | KP_Delete | KP_Home | KP_End | KP_PageUp
KP_PageDown | KP_Up | KP_Down | KP_Left | KP_Right | KP_Enter
KP_Add | KP_Subtract | KP_Divide | KP_Multiply
KP_0 to KP_9

Function keys

F1 | F2 | F3 | F4 | F5 | F6 | F7 | F8 | F9 | F10 | F11 | F12

Codes with special meanings

- + means press down the following key
- means release the following key
- * means wait 250ms

Other products in the Adder range

The following complementary KVM switch devices are available:

- SmartView 4XPRO 16 port (part code: SV4X16)
- SmartView 2XPRO 8 port (part code: SV2X8)
- SmartView 2XPRO 4 port (part code: SV2X4)
- AdderView Matrix 208 (part code: AVM208)
- AdderView Matrix 216 (part code: AVM216)

Warranty

Adder Technology Ltd warrants that this product shall be free from defects in workmanship and materials for a period of two years from the date of original purchase. If the product should fail to operate correctly in normal use during the warranty period, Adder will replace or repair it free of charge. No liability can be accepted for damage due to misuse or circumstances outside Adder's control. Also Adder will not be responsible for any loss, damage or injury arising directly or indirectly from the use of this product. Adder's total liability under the terms of this warranty shall in all circumstances be limited to the replacement value of this product.

If any difficulty is experienced in the installation or use of this product that you are unable to resolve, please contact your supplier.

Safety information

- For use in dry, oil free indoor environments only.
- Warning - live parts contained within power adapter.
- No user serviceable parts within power adapter - do not dismantle.
- Plug the power adapter into a socket outlet close to the module that it is powering.
- Replace the power adapter with a manufacturer approved type only.
- Do not use the power adapter if the power adapter case becomes damaged, cracked or broken or if you suspect that it is not operating properly.
- If you use a power extension cord with the AdderLink IP, make sure the total ampere rating of the devices plugged into the extension cord does not exceed the cord's ampere rating. Also, make sure that the total ampere rating of all the devices plugged into the wall outlet does not exceed the wall outlet's ampere rating.
- Do not attempt to service the AdderLink IP yourself.

Safety considerations when using power switches with AdderLink IP

- Follow the manufacturer's instructions when setting up and using power switching products.
- Always ensure that the total ampere rating of the devices plugged into the power switching product does not exceed the power switching product's ampere rating. Also, make sure that the total ampere rating of all the devices plugged into the wall outlet does not exceed the wall outlet's ampere rating.

General Public License (Linux)

The AdderLink IP runs an embedded version of the Linux operating system, licensed under the GNU General Public License. To obtain the source code for the open-source components of the system visit:

<http://www.realvnc.com/products/AdderLinkIP/gpl.html>.



INSTALLATION

CONFIGURATION

OPERATION

FURTHER INFORMATION

INDEX

End user licence agreement

PLEASE READ THIS AGREEMENT CAREFULLY. THIS AGREEMENT CONCERNS ENHANCED VNC VIEWER SOFTWARE (“the SOFTWARE”) FOR USE WITH THE ADDERLINK IP PRODUCT (“the PRODUCT”). THE SOFTWARE IS PROVIDED TO ENABLE YOU TO OPERATE THE PRODUCT. BY USING ALL OR ANY PORTION OF THE SOFTWARE YOU ACCEPT ALL THE TERMS AND CONDITIONS OF THIS AGREEMENT. IF YOU DO NOT ACCEPT ALL THE TERMS AND CONDITIONS OF THIS AGREEMENT THEN DO NOT USE THE SOFTWARE. BY USING ANY UPDATED VERSION OF THE SOFTWARE WHICH MAY BE MADE AVAILABLE, YOU ACCEPT THAT THE TERMS OF THIS AGREEMENT APPLY TO SUCH UPDATED SOFTWARE.

1. Intellectual Property Rights

The Software and its structure and algorithms are protected by copyright and other intellectual property laws, and all intellectual property rights in them belong to RealVNC Limited (“RealVNC”), a United Kingdom Limited Company, or are licensed to it. You may not reproduce, publish, transmit, modify, create derivative works from, publicly display the Software or part thereof. Copying or storing or using the Software other than as permitted in Clause 2 is expressly prohibited unless you obtain prior written permission from RealVNC.

2. Permitted and Prohibited Uses

- 2.1 During the term of this Agreement and as long as you comply with the terms of this agreement, you may use the Software only with the Product for your personal use or for the internal use of your business. You may make as many copies of the Software as you require for your own internal business purposes only and for archival purposes. You are expressly prohibited from distributing the Software in any format, in whole or in part, for sale, or for commercial use or for any unlawful purpose.
- 2.2 You may not rent, lease or otherwise transfer the Software or allow it to be copied. Unless permitted by law, you may not reverse engineer, decompile or disassemble the Software.

3. Warranty

REALVNC DOES NOT WARRANT ANY RESULTS OBTAINED USING THE SOFTWARE. TO THE EXTENT PERMITTED BY LAW, REALVNC DISCLAIMS ALL OTHER WARRANTIES ON THE SOFTWARE, EITHER EXPRESS OR IMPLIED, INCLUDING BUT NOT LIMITED TO THE IMPLIED WARRANTIES OF MERCHANTABILITY, NON-INFRINGEMENT OF THIRD PARTY RIGHTS AND FITNESS FOR PARTICULAR PURPOSE.

4. Limitation on Liability

UNDER NO CIRCUMSTANCES SHALL REALVNC BE LIABLE FOR ANY CONSEQUENTIAL INDIRECT OR INCIDENTAL DAMAGES WHATSOEVER INCLUDING LOST PROFITS OR SAVINGS ARISING OUT OF THE USE OF THE SOFTWARE, THE SERVICE OR THE INFORMATION, RELIANCE ON THE DATA PRODUCED OR INABILITY TO USE THE SOFTWARE, THE SERVICE OR THE INFORMATION EVEN IF REALVNC HAS BEEN ADVISED OF THE POSSIBILITY OF SUCH DAMAGES. BECAUSE SOME STATES AND COUNTRIES DO NOT ALLOW THE EXCLUSION OR LIMITATION OF LIABILITY FOR CONSEQUENTIAL OR INCIDENTAL DAMAGES, THE ABOVE LIMITATION MAY NOT APPLY TO YOU. NOTHING IN THIS AGREEMENT LIMITS LIABILITY FOR DEATH OR PERSONAL INJURY ARISING FROM A PARTY’S NEGLIGENCE OR FROM FRAUDULENT MISREPRESENTATION ON THE PART OF A PARTY

5. Export Control

The United States and other countries control the export of Software and information. You are responsible for compliance with the laws of your local jurisdiction regarding the import, export or re-export of the Software, and agree to comply with such restrictions and not to export or re-export the Software where this is prohibited. By downloading the Software, you are agreeing that you are not a person or entity to which such export is prohibited.

6. Term and Termination

This licence shall continue in force unless and until it is terminated by RealVNC by e-mail notice to you, if it reasonably believes that you have breached a material term of this Agreement

In the case above, you must delete and destroy all copies of the Software in your possession and control and overwrite any electronic memory or storage locations containing the Software.

7. General Terms

- 7.1 The construction, validity and performance of this Agreement shall be governed in all respects by English law, and the Parties agree to submit to the exclusive jurisdiction of the English courts.
- 7.2 If any provision of this agreement is found to be invalid by any court having competent jurisdiction, the invalidity of such provision shall not affect the validity of the remaining provisions of this agreement, which shall remain in full force and effect.
- 7.3 No waiver of any term of this agreement shall be deemed a further or continuing waiver of such term or any other term.
- 7.4 This agreement constitutes the entire agreement between you and RealVNC.



INSTALLATION

CONFIGURATION

OPERATION

FURTHER INFORMATION

INDEX

Radio Frequency Energy

A Category 5 (or better) twisted pair cable must be used to connect the AdderLink units in order to maintain compliance with radio frequency energy emission regulations and ensure a suitably high level of immunity to electromagnetic disturbances.

All other interface cables used with this equipment must be shielded in order to maintain compliance with radio frequency energy emission regulations and ensure a suitably high level of immunity to electromagnetic disturbances.

European EMC directive 89/336/EEC

This equipment has been tested and found to comply with the limits for a class A computing device in accordance with the specifications in the European standard EN55022. These limits are designed to provide reasonable protection against harmful interference. This equipment generates, uses and can radiate radio frequency energy and if not installed and used in accordance with the instructions may cause harmful interference to radio or television reception. However, there is no guarantee that harmful interference will not occur in a particular installation. If this equipment does cause interference to radio or television reception, which can be determined by turning the equipment on and off, the user is encouraged to correct the interference with one or more of the following measures: (a) Reorient or relocate the receiving antenna. (b) Increase the separation between the equipment and the receiver. (c) Connect the equipment to an outlet on a circuit different from that to which the receiver is connected. (d) Consult the supplier or an experienced radio/TV technician for help.

FCC Compliance Statement (United States)

This equipment generates, uses and can radiate radio frequency energy and if not installed and used properly, that is, in strict accordance with the manufacturer's instructions, may cause interference to radio communication. It has been tested and found to comply with the limits for a class A computing device in accordance with the specifications in Subpart J of part 15 of FCC rules, which are designed to provide reasonable protection against such interference when the equipment is operated in a commercial environment. Operation of this equipment in a residential area may cause interference, in which case the user at his own expense will be required to take whatever measures may be necessary to correct the interference. Changes or modifications not expressly approved by the manufacturer could void the user's authority to operate the equipment.

Canadian Department of Communications RFI statement

This equipment does not exceed the class A limits for radio noise emissions from digital apparatus set out in the radio interference regulations of the Canadian Department of Communications.

Le présent appareil numérique n'émet pas de bruits radioélectriques dépassant les limites applicables aux appareils numériques de la classe A prescrites dans le règlement sur le brouillage radioélectriques publié par le ministère des Communications du Canada.



INSTALLATION

CONFIGURATION

OPERATION

FURTHER INFORMATION

INDEX

© 2004 Adder Technology Limited
All trademarks are acknowledged.
Release 1.0b
June 2004
Part No. ADD0053

Adder Technology Limited,
Technology House,
Trafalgar Way, Bar Hill,
Cambridge, CB3 8SQ,
United Kingdom
Tel: +44 (0)1954 780044
Fax: +44 (0)1954 780081

Adder Corporation,
29 Water Street,
Newburyport,
MA 01950,
United States of America
Tel: +1-888-932-3337
Fax: +1-888-275-1117

INSTALLATION

CONFIGURATION

OPERATION

FURTHER
INFORMATION

INDEX

Index



A

- Access control
 - configuration 49
 - mask calculation 55
- Access mode
 - shared & private 27
- Account
 - creation for users 45
- Address
 - explanation 53
- Addressing
 - DNS 18
 - network issues 18
 - power switch boxes 10
- Admin password
 - initial setup 12
 - local setting 34
- Advanced unit configuration 47
- Artifacts
 - on screen 25
- Auto select 39,43

B

- Baud rate
 - local setting 36
 - remote setting 50
- Binary
 - net masks 54
- Brackets 5
 - fitting 6
- Browser
 - connection 24

C

- Cable specifications 53,57,58
- Calibrate
 - mouse 27
 - screen 27
- Calibrate all
 - video settings 29
- Clear IP access control
 - local setting 35
- Client IP
 - local setting 36
- Colour level 39
- COM1
 - baud rate 50
 - connection 9
- COM2
 - baud rate 50
 - connection 10
- Configuration switches 4
- Connections
 - host computer 7
 - ISDN 9
 - keyboard 8
 - KVM switch 7
 - local 22
 - modem 9
 - monitor 8
 - mouse 8
 - network port 8
 - power supply 9
 - remote 23
- Connector specifications 57
- Controls
 - viewer options 28
- Control menus
 - for local connection 33
 - for remote connection 25,44
- Control strings
 - power switching 20

D

- Daisy chain cable 57
- Date
 - local setting 34
 - remote setting 46
- DHCP
 - discovering allocations 18
 - during initial setup 12
 - local setting 21,35
 - remote setting 48
- Dial up
 - connection 30
- DNS addressing 18

E

- Encryption key 12
- End user licence 60

F

- Firewall 17
- Firmware
 - current version 46
 - upgrade 21
- Flash upgrade 21
- Force encryption 34
- Full screen mode
 - escape from (F8) 25

G

- Gateway
 - local setting 21,35
 - remote setting 48

H

- Hextile 39,43
- Hosts
 - changing between 25

- Host computer
 - connecting 7
 - power switching setup 20
- Host configuration 51
- Host selection 26
- Hotkeys
 - to access menus 33
- Hot keys
 - changing 34
 - remote setting 46
- HTTP port
 - initial setup 12
 - local setting 35
 - remote setting 48
 - when altered 17

I

- IEC power lead 9
- Indicators 4
- Initialise button 50
- Initialize port
 - local setting 36
- Initial configuration 11
- Init string
 - local setting 36
- IntelliMouse 14
- IP access control 48,49
 - calculating mask 55
- IP address
 - explanation 53
 - local setting 21,35
 - remote setting 48
- IP gateway 48
- IP network mask 48
- IP network port 4
 - connecting 8
- ISDN
 - connecting 9
 - dial up link 30

K

- Keyboard codes
 - sending 28
- Keyboard Layout
 - remote setting 46
- Keyboard layout
 - local setting 34
- KVM console 4
- KVM switch
 - connecting 7

L

- Local connection 22
- local control menus 33
- Local network
 - connection 17
- Logging 52
- Log on 24

M

- MAC address 35,48
- Mask
 - explanation 53
 - for IP access control 55
- Menus
 - local 33
 - remote 44
- Menu bar
 - viewer window 25
- Menu key
 - changing 40
- Modem
 - connecting 9
 - dial up link 30
- Modem configuration 36
- Modem port 4
- Mounting 6

INSTALLATION

CONFIGURATION

OPERATION

FURTHER INFORMATION

INDEX

- Mouse
 - restoration 13,14
- Mouse calibration 27
- Mouse control 28

N

- Networking issues 17
- Network configuration 35,48
- Network port
 - connecting 8
- Net mask 21,35
 - explanation 53

O

- Octets
 - ip address 53

P

- Password
 - admin - setting 34
 - initial setup 12
 - remote logon 24
 - setting for users 45
 - unknown 15
- Port number
 - entering 30
- Power control port 4
 - connecting 10
- Power strings
 - for switching 20
- Power supply
 - connecting 9
- Power switching
 - addressing 10
 - configuration 20
 - on & off select 27
 - user permissions 45
- PPP client IP address 50
- PPP server IP address 50
- Preferred encoding 39
- Private
 - access mode 27

R

- Rack mounting 6
- Raw 39,43
- RealVNC 4
- Remote configuration 16
- Remote connection 23
- Reset
 - to factory defaults 15
- Reset configuration 37
- Restore Defaults
 - local setting 36
- RJ9 connector 10
- Router 17

S

- Safety information 59
- Screen
 - best resolution 25
 - navigation 25
- Screensaver
 - local setting 34
 - remote setting 46
- Serial port
 - modem connection 9
- Serial port configuration 50
- Server IP
 - local setting 36
- Setup procedure
 - local setup 11
 - remote setup 16
- Shared
 - access mode 27
- Slow connections
 - optimising for 25
- Supplied items 5

T

- Time
 - local setting 34
 - remote setting 46
- Troubleshooting 32

U

- Unit configuration 34,46
- Unit name
 - local setting 34
 - remote setting 46
- Upgrade
 - firmware 21
- USB converter 5
- Username
 - initial setup 13
 - remote logon 24
- User accounts 45
- Use DHCP
 - local setting 21,35

V

- Video settings 29
- Viewer window 25
- VNC port
 - initial setup 12
 - local setting 35
 - remote setting 48
 - when altered 17
- VNC viewer
 - configuration menus 44
 - connection 24
 - connection options 39
 - download 30
 - window options 42

W

- Warranty 59
- Web browser
 - connection 24
 - viewer options 43

Z

- ZRLE 39,43



INSTALLATION

CONFIGURATION

OPERATION

FURTHER INFORMATION

INDEX